

# LONGITUDINAL IMPEDANCE MEASUREMENT OF THE STRIP-LINE KICKER FOR HIGH ENERGY PHOTON SOURCE (HEPS)

S.K. Tian<sup>†</sup>, N. Wang, J.H. Chen, H. Shi, L. Wang, Y. Jiao

Key Laboratory of Particle Acceleration Physics and Technology, Institute of High Energy Physics, Chinese Academy of Sciences, 100049 Beijing, China

## Abstract

The High Energy Photon Source (HEPS) is a 6-GeV, kilometre-scale storage ring light source to be built in China. One of the main design challenges of the storage ring is to minimize collective instabilities associated with the impedance of small-aperture vacuum components. In this paper we present beam coupling impedance measurements obtained by the well-known coaxial wire method, for the HEPS strip-line kicker. The frequency dependent real and imaginary parts of the distributed impedance are obtained from the measured S-parameters.

## INTRODUCTION

In the framework of the design study of High Energy Photon Source (HEPS), a kilometre scale quasi-diffraction limited storage ring light source with the beam energy of 6 GeV to be built in Beijing area, most of the parameter choices are driven by the requirement for the unprecedented low emittances. The main design parameters [1] of the HEPS are summarized in Table 1. The layout and optical functions of one 7BA are shown in Figure 1.

Table 1: HEPS Lattice Design Parameters

Parameters	Values
Energy $E_0$	6 GeV
Beam current $I_0$	200 mA
Circumference	1360.4 m
Natural emittance $\epsilon_{x0}$	34.2 pm.rad
Working point $\nu_x/\nu_y$	114.14/106.23
Natural chromaticity (H/V)	-215.9/-292.2
No. of super-periods	24
ID section length $L_{ID}$	6.00/6.07m
RMS energy spread	$1.061 \times 10^{-3}$
Momentum compaction	$1.561 \times 10^{-5}$
Energy loss per turn	2.888 MeV

The HEPS will operate with bunch swap out and vertical on-axis injection. In this scheme, a target bunch will be extracted to a beam dump and the resulting empty RF bucket filled with a replacement bunch from the booster. The planned 680 bunch fill pattern (high-brightness mode) places difficult demands on the injection and extraction kickers. The present concept uses dual strip-line kickers driven by high voltage (HV) pulser. Minimizing perturbation on adjacent bunches requires very fast rise and fall times with relatively narrow pulses.

<sup>†</sup> tiansk@ihep.ac.cn

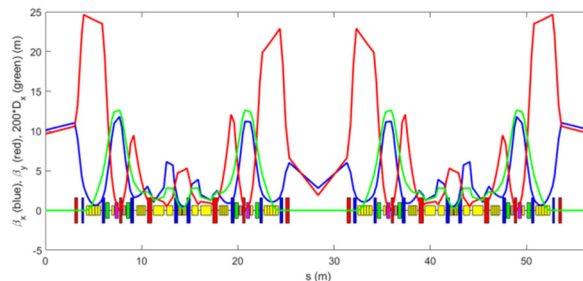

Figure 1: Optical functions and layout of one period.

The strip-line kicker cross section is shown in Figure 2. There are tapered end sections for matching impedance to the feed-throughs and two “D” shaped blades used to improve field-uniformity, an ellipse outer body with vanes geometry is adopted to ease common-mode impedance-matching. Because the small gap (gap=5mm) between the blades, the strip-line kicker is one of the major beam coupling impedance contributions. In order to have a better knowledge about the beam coupling impedance of a strip-line kicker, we plan to measure the longitudinal coupling impedance of the kicker.

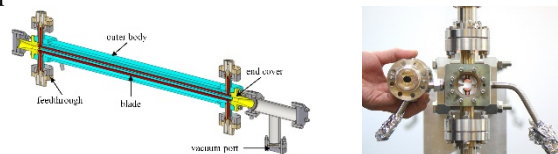

Figure 2: 3D model and cross section of the strip-line kicker.

## MEASUREMENT SETUP

Longitudinal coupling impedances can be deduced from scattering parameters(S-parameters) measurements performed on a coaxial wire. The coaxial wire method is a well-established technique for the deduction of coupling impedances. The wire is mimicking the particle beam. A coaxial shield is used to guide the electromagnetic fields. Coaxial tapers on both ends adapt the wave impedance to the 50  $\Omega$  impedance of coaxial cables, sources and receivers. Using a vector network analyzer (VNA), S-parameters of the setup with the device under test (DUT) and the smooth reference beam pipe (REF) are obtained. These measurements are sufficient to mathematically deduce coupling impedances of the DUT.

The impedance measurement experimental set up consists of a strip-line kicker as DUT, a pure aluminium pipe as REF, the KEYSIGHT E5071C ENA and N4433A Electronic calibration kit for S-parameters measurement over a wide spectral range up to 20 GHz with the help of 3.5 mm coaxial cables which provides 50  $\Omega$  matching network at

Content from this work may be used under the terms of the CC BY 3.0 licence (© 2018). Any distribution of this work must maintain attribution to the author(s), title of the work, publisher, and DOI.

both ends of the DUT and REF. There are two types of wire used in this measurement ( $r = 0.25\text{mm}$  and  $r = 0.15\text{mm}$ ). It should be noted that an adjuster section and a matching section are placed at either end of the DUT in order to minimize losses of the signal from the VNA. There is a  $50\ \Omega$  matched load connected with the feed-throughs. The bench measurement set up is shown in Figures 3 and 4.

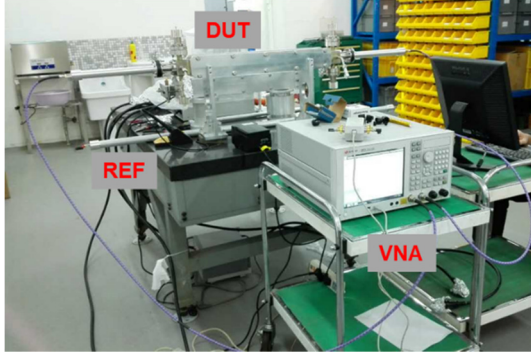

Figure 3: Lab set-up of network analyzer impedance measurements.

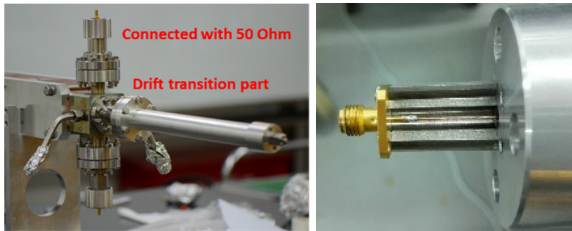

Figure 4: The adjuster section and matching section.

## COMPARISON OF MEASUREMENTS AND SIMULATION

There are several formulas that can be used to calculate the longitudinal impedance from the measured S-parameters. For a lumped device, i.e. short compared to the wave length, the impedance could be given by Hahn-Pedersen formula (HP formula) [2]:

$$Z_{HP} = -2Z_c \left( \frac{S_{21,DUT} - S_{21,REF}}{S_{21,DUT}} \right) \quad (1)$$

with  $S_{21,REF}$  and  $S_{21,DUT}$  are the measured transmission coefficients of a smooth reference pipe and the DUT respectively.  $Z_c$  is the characteristic impedance for a coaxial line:

$$Z_c = \frac{Z_0}{2\pi} \ln \left( \frac{b}{a} \right) \quad (2)$$

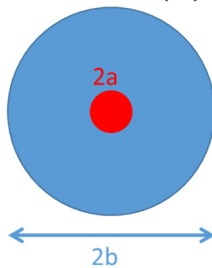

Figure 5: Relevant geometry of a coaxial beam pipe.

For the strip-line kicker impedance measurement experimental, the coaxial line characteristic impedance is about  $227\ \Omega$  with  $a=0.25\text{mm}$  and  $b=11\text{mm}$  as shown in Figure 5.

In the course of measuring distributed structures such as kickers, it was noticed that the HP formula can yield unphysical negative resistances. Using Falten's model [3] for distributed wall impedances, Walling et al, introduced the log formula for use in structures which are longer than the beam tube diameter [4]:

$$Z_{\log} = -2Z_c \ln \left( \frac{S_{21,DUT}}{S_{21,REF}} \right) \quad (3)$$

Several so-called improved log formulae have been suggested but are of questionable value, under certain conditions, better results and deserves to be compared to the standard formulae. The well-known improved log formula is Vaccaro formula [5]:

$$Z_{Vaccaro} = -2Z_c \ln \left( \frac{S_{21,DUT}}{S_{21,REF}} \right) \left[ 1 + \frac{\ln(S_{21,DUT})}{\ln(S_{21,REF})} \right] \quad (4)$$

Which was further discussed by E. Jensen [6]:

$$Z_{Jensen} = -2Z_c \ln \left( \frac{S_{21,DUT}}{S_{21,REF}} \right) \left[ 1 + \frac{c}{4\pi fL} \ln \left( \frac{S_{21,DUT}}{S_{21,REF}} \right) \right] \quad (5)$$

where  $c$  is the light velocity,  $f$  is frequency, and  $L$  is the length of DUT.

The log formula is easy to use and represents a good approximation for a distributed impedance, so log formula was used in our experimental data processing.

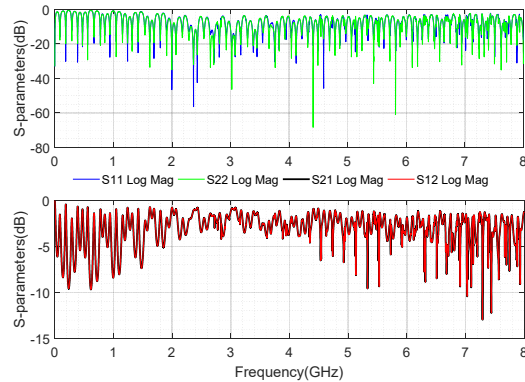

Figure 6: Measured S-parameters for DUT.

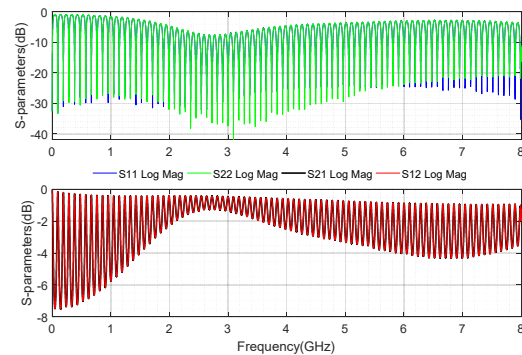

Figure 7: Measured S-parameters for REF.

We scanned the S-parameters over the range 0-20 GHz, but there are some high peaks above 4GHz, which are supposed to be introduced by the poor matching at the feed-throughs or higher modes other than TEM. The cut-off frequency of the side beam pipe is about 8.0GHz (with  $r_{out}/r_{in}=11\text{mm}/0.25\text{mm}$ ), so we chose the specific band 0~8GHz as shown in Figures 6 and 7.

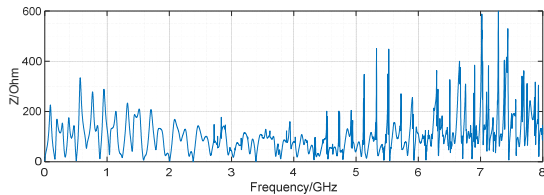

Figure 8: Longitudinal impedance of strip-line kicker from measured S-parameters.

Using the log formula(3), we got the longitudinal impedance of strip-line kicker as shown in Figure 8, we found there are resonances about every 175 MHz, and the amplitude of the resonances is around 200 Ohm.

We also do some simulations about the strip-line kicker by using the code CST Studio Suite [7]. Using the wake-field solver of CST PARTICLE STUDIO, we could get the wake potential and impedance of the kicker. In the wake-field solver, the structure is excited by a line current (longitudinally Gaussian shaped charge distribution) representing the beam. Using the Time Domain solver of CST MICROWAVE STUDIO and Waveguide Port, we could get the S-parameters of the kicker as we do in the impedance measurement experiment. The CST model used was shown in Figure 9.

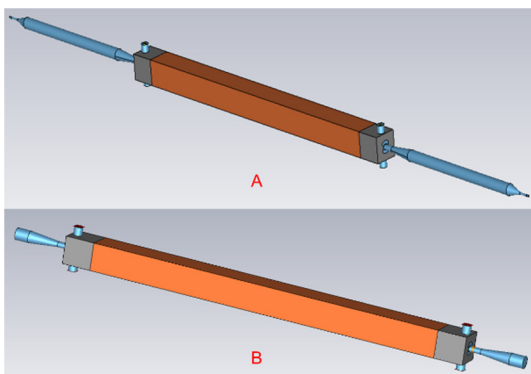

Figure 9: Simulation models. A: model used in CST MICROWAVE STUDIO, B: model used in CST PARTICLE STUDIO.

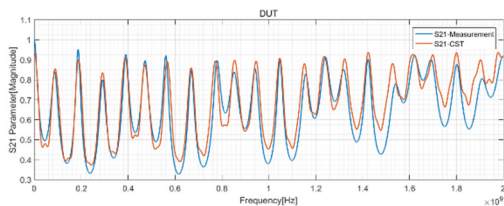

Figure 10: Measured and simulated S-parameters for DUT.

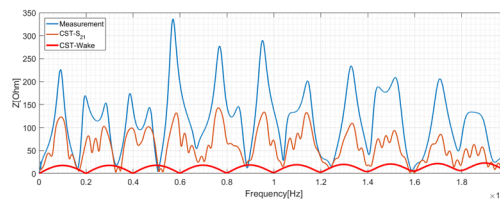

Figure 11: Impedance comparison between measurement and simulations.

The S-parameters agreement between simulation and measurement are reasonably good as shown in Figure 10. The impedance from S parameter simulation shows the same frequency characteristic compare to the coaxial measurement, but with lower amplitude. The impedance from wake-field simulation gives much lower amplitude and the repetition period of the resonances is larger as shown in Figure 11. The difference may be from the additional cavity structure introduced by the drift transition.

## DISCUSSION

The impedance measurements on strip-line kicker for the HEPS storage rings agree with the impedance from S parameter simulation, but not agree well with the impedance from wake-field simulation. The end matching section is not ideal resulting in a large signal reflection. The issues that optimization design matching section and careful design the sucobox are ongoing.

## ACKNOWLEDGEMENT

The authors would like to acknowledge L.S. Huang for his most valuable advices on the improvements of the measurement system. The work is supported by NSFC (11775239), NKPSTRD (2016YFA0402001) and Key Research Program of Frontier Sciences CAS (QYZDJ-SSW-SLH001).

## REFERENCES

- [1] Y. Jiao *et al.*, “Evolution of the Lattice Design for the High Energy Photon Source”, presented at the 9th Int. Particle Accelerator Conf. (IPAC’18), Vancouver, Canada, Apr.-May 2018, paper TUPMF049, this conference.
- [2] H. Hahn and F. Pedersen, “On Coaxial Wire Measurement of the Longitudinal Coupling Impedance”, BNL 50870, USA, 1978.
- [3] A. Faltens *et al.*, “An Analog Method for Measuring the Longitudinal Coupling Impedance of a Relativistic Particle Beam with its Environment”, *Proc. Int. Conf. on High Energy Act.*, CERN, Switzerland, 1971, p. 338.
- [4] L.S. Walling, D.E. McMurray, D.V. Neuffer and H.A. Thiesen, *Nucl. Instr. & Methods A*281, p. 433 (1989).
- [5] V.G. Vaccaro, “Coupling Impedance Measurements: An Improved Wire Method”, INFN/TC-94/023 (1994).
- [6] E. Jensen, “An Improved Log-formula for Homogeneously Distributed Impedance”, PS/RF/Note 2000-001 (2000).
- [7] www.cst.com