

# DESIGN STUDY OF PM DIPOLE FOR ILC DAMPING RING

Y. Iwashita<sup>†</sup>, ICR, Kyoto Univ., 611-0011, Uji, Kyoto, JAPAN  
 N. Terunuma, KEK, 305-0801, Tsukuba, Japan

## Abstract

Dipole magnet using permanent magnet technology is under investigation for ILC. It can reduce the cost of electricity for coil excitation and cooling water pump, thick electric cabling and water piping, power supply, and their maintenance cost. The structure and the field adjustment scheme of a trial conceptual design will be discussed.

## INTRODUCTION

ILC Damping Ring (DR) has been designed by the well-established experiences on the past and coming ring accelerators. Although the cost of DR accelerator is about 4 % of total in the Technical Design Report (TDR) [1] and the impact of cost reduction for DR by new technology is limited, there may be a room to discuss, for example, permanent magnet for main dipole. Some studies on PM dipoles as main dipoles have been reported [2,3]. When the main dipole magnets are excited by permanent magnets, no DC power supplies, no cooling water, and then these failures will never happen. This also eliminates thick power cables and their wiring in addition to the electricity saving. Water leaks would be annoying events among maintenance activities, which would also be dramatically reduced if permanent magnets were applied. These items offer cost reductions for both construction and operations.

While many advantages are expected, we need some investigations in applying permanent magnets to the ring. At least three subjects have to be considered: temperature dependence of remnant field ( $B_r$ ), adjustability and demagnetization caused by radiation. The temperature coefficient can be compensated by magnetic shunts made of low Curie temperature magnetic materials [4]. Although the strength adjustment of magnets made of permanent magnets are not easy compared with electromagnets, there are some methods that can be incorporated. When the permanent magnet part is fixed in a magnetic circuit, we may change magnetic reluctance and/or magnetic shunt in the magnetic circuit for strength adjustment. The methods can be considered as series pass regulator and shunt regulator, respectively. Another way to change the magnetic flux density generated in a gap is to move or rotate permanent magnets in the structure, which enables a bipolar operation and is suitable for correction magnets.

Figure 1 shows the ILC damping-ring layout, where 304 correction dipoles are located in addition to 150 3-m long main dipole magnets at the arcs. The layout of the magnets is shown in Fig. 2. Since there is a plan that the natural emittance of the damping ring will be made smaller than the TDR design toward higher luminosity, the reduced magnetic field strength of the main dipole mag-

net with a 5-m magnet length is planned. The resulted magnetic field would be 1.3kG, which can be generated by ferrite magnets. While ferrite magnets are not expensive, no information on radiation demagnetization is available for now.

Possible designs of the main dipoles and the correction magnets are discussed in following sections.

## MAIN DIPOLE MAGNET

The main dipoles are massive magnets in their total volume. The required magnetic field level 1.3 kG allows us to use low cost ferrite magnets to generate it. While the temperature coefficient of  $B_r$  is somewhat higher than rare earth magnets, some compensation technics are available. In addition to the field stability, field adjustability and maintainability are to be considered. Because the magnets are installed on stacked shelves, their heights are limited to 50 cm. Since the 5-m length of a magnet is too long to handle, it will be divided into five 1-m magnets with C-shape for easy installation of vacuum cham-

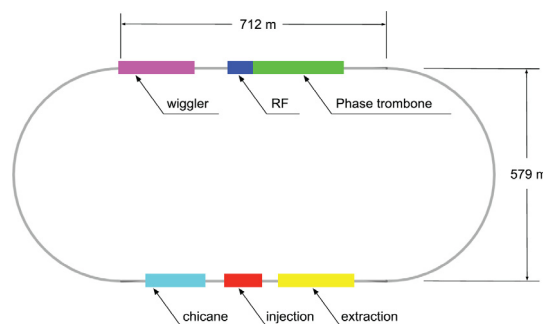

Figure 1: Damping-ring layout: the circumference is 3238.7m; the length of each straight is 710.2 m. (from ILC TDR Vol.3-II, Fig.6.1)

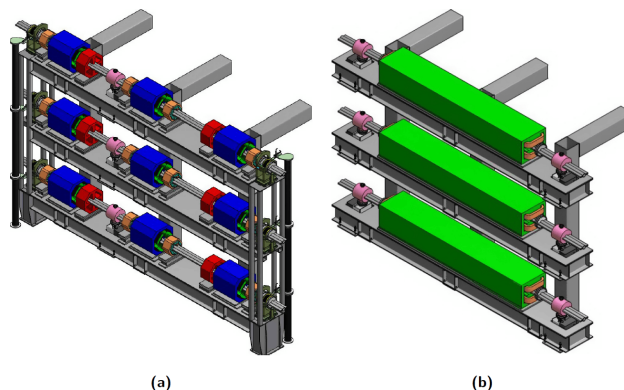

Figure 2: Damping-ring arc magnet layout with positron ring at the bottom and electron ring directly above. A second positron ring would be placed above the electron ring if required: (a) quadrupole section layout and (b) dipole section layout. (from ILC TDR Vol.3-II, Fig.6.2)

<sup>†</sup> iwashita@kyticr.kuicr.kyoto-u.ac.jp

Content from this work may be used under the terms of the CC BY 3.0 licence (© 2018). Any distribution of this work must maintain attribution to the author(s), title of the work, publisher, and DOI.

bers. The gap distance of the magnet is assumed to be 60 mm to incorporate with the beam chamber described in TDR. A rough sketch of the 1m long PM dipole is shown in Fig. 3. 150 mm pole width of the magnet should be enough to keep the field flatness of 100 ppm in the beam aperture. Permanent magnet blocks of 150x200x50 are located close to the gap area for a better flux efficiency and less flux leakage. Five blocks are installed at each side of the pole plate: top and bottom. The magnet blocks are demountable so that damaged magnets can be replaced. This feature also enables us to store or transport the magnet assembly without excitation by removing all permanent magnet blocks.

Figure 4 shows the cut view of the magnet at the return yoke. The low-density flux is concentrated to the two return yoke legs for less volume of the iron part with enough mechanical strength. Since the cross section at the median plane in the gap is 1500 cm<sup>2</sup> and the flux density is 1.3kG, total cross section of 300 cm<sup>2</sup> should be enough for the two return yokes. A motor driven rotor is inserted at each side of the return yoke.

The 10-mm non-magnetic space gaps in the rotor

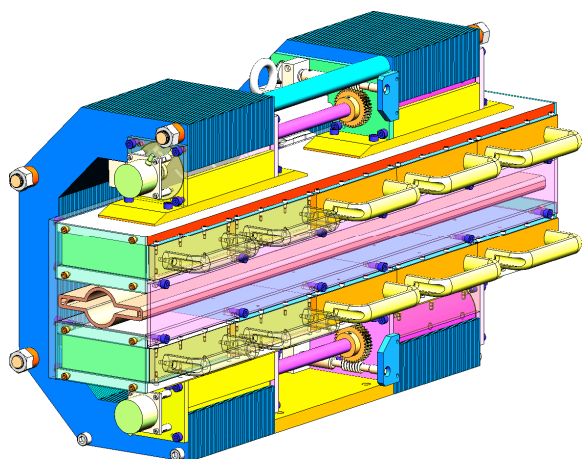

Figure 3: Overview of possible design of PM dipole for ILC damping ring.

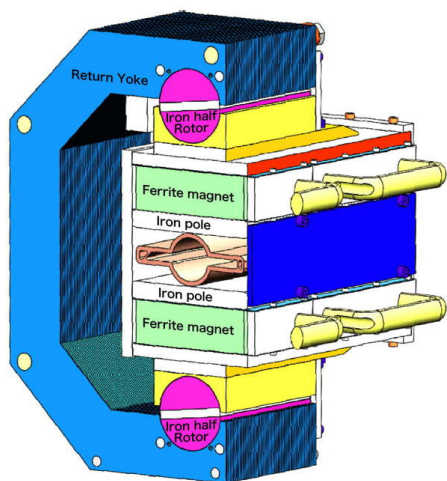

Figure 4: Cut view at the return yoke. By rotating the rotor, the magnetic reluctance is varied to adjust the magnetic field generated in the gap.

change magnetic reluctance to adjust the magnetic field in the gap about 10%. Two rotors at each jaw of the return yoke are connected together with a rod and four of them are driven by a stepping motor while the angle is monitored by a rotary encoder installed at each jaw.

Figure 5 shows how the flux flows depending on the rotor angle. When the rotor gap is vertical, the magnetic reluctance becomes small and the field in the beam aperture is high (see Fig. 5a). On the other hand, the horizontal position of the rotor makes the field strength small (Fig. 5b). The field variation as a function of rotation angle is shown in Fig.6. The steep variation at the low field side may be reduced by modifying the rotor shape.

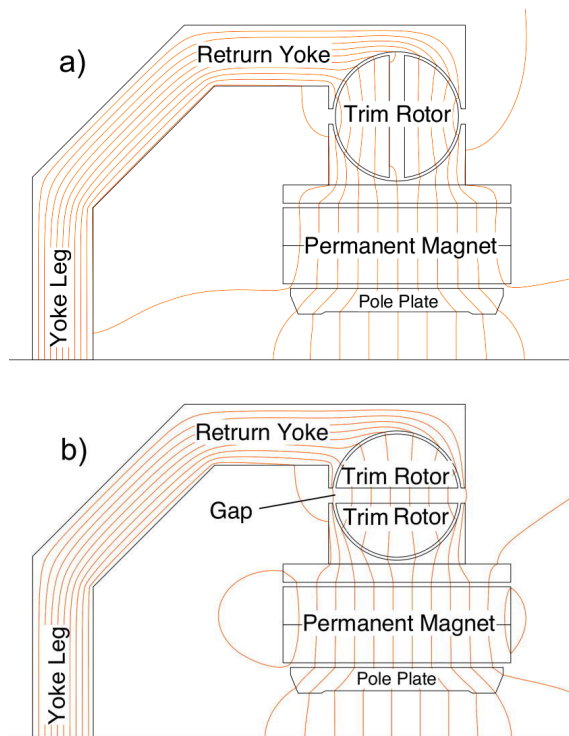

Figure 5: Field adjustment by the rotor with non-magnetic gap.

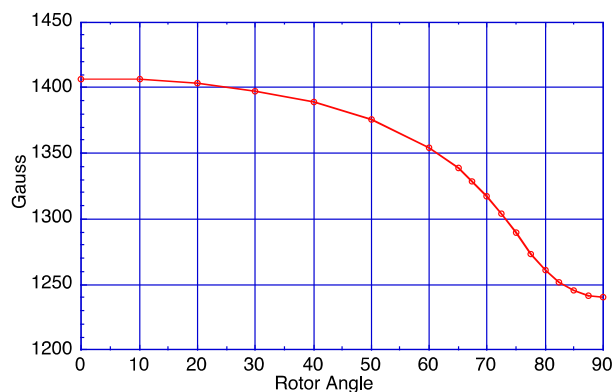

Figure 6: Field variation with the rotation angle of the rotor. About 10% variation is available with 10mm gap in the rotor.

## CORRECTION MAGNET

The number of correction magnets in the ring is 304. There are also more requirements for such correction magnets in beam lines such as RTML (Ring To Main Linac). Their variable range of magnetic field has to be bipolar, which can be realized by rotation of magnets. Figure 7 shows a proposed bipolar correction magnet, where four magnet rods located at four corners of a rectangle are rotated by a stepping motor to vary the magnetic field distribution. Flux line plot is shown in Figure 8, where the adjacent rods rotate in opposite directions so that the magnetic field is perpendicular to the median plane and the integrated magnetic field along the axis (so called BL product) can be cancelled out in a short period. Figure 9 shows the field distribution along beam line at three rod angles. The effective correction angle is proportional to the BL product along the axis (see Figure 10). As can be seen, the BL product changes sinusoidally with the rotation angle. Suppose that the BL product of the main magnet is  $1.3\text{kG} \times 5\text{m} = 6.5\text{kG}$ , about 1% correction range of the main dipole can be achieved with this configuration.

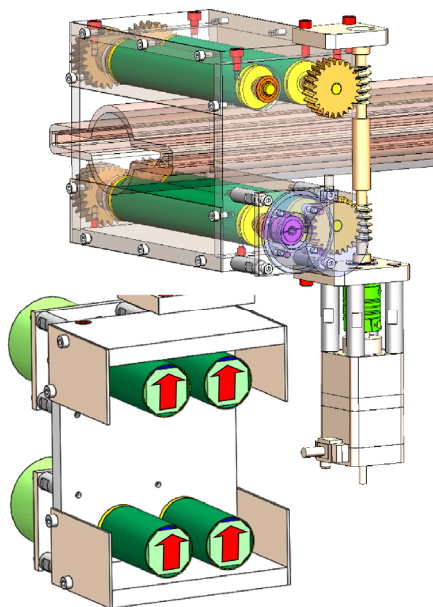

Figure 7: Sketch of a correction magnet and its cut view.

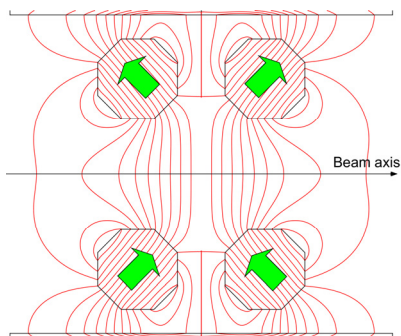

Figure 8: Flux plot of 2-D calculation. The arrows denote the easy axis of the magnet rods. The magnet angles are at  $45^\circ$  to generate 70% of the maximum BL product.

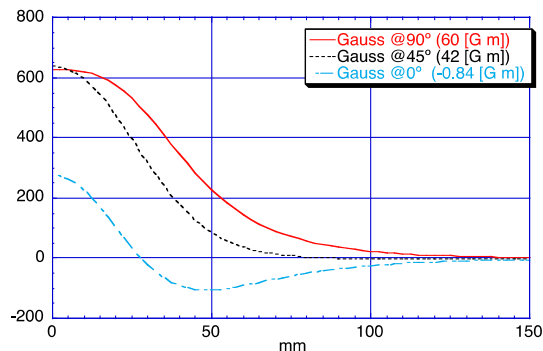

Figure 9: Field distribution along beam line.

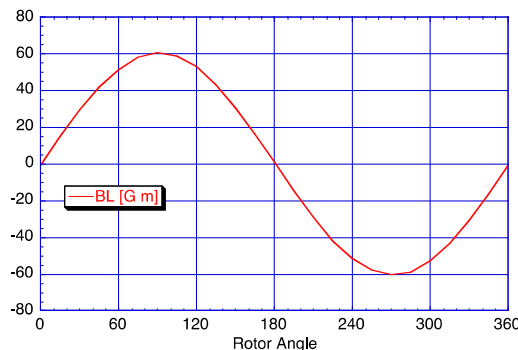

Figure 10: BL product as a function of rotor angle.

## CONCLUSION

Permanent magnet is considered as the main magnet for ILC damping ring. It has a possibility to reduce the fabrication cost in addition to the operation and maintenance cost. A conceptual design of the magnet is proposed using less expensive ferrite magnet compared with strong rare earth magnets. Magnetic field adjustability for the main dipole can be realized through variation of magnetic reluctance by mechanical rotations of non-uniform iron rods. That for correction magnet can be realized by rotation of magnet rods, which vary the magnetic field distribution. Temperature dependence of the magnet material can be cancelled by shunt circuit with special magnetic material and/or the adjustability function. Since there is not much information on demagnetization caused by radiation of ferrite magnets, studies on the issue will be planned.

## REFERENCES

- [1] ILC Technical Design Report (TDR). <https://www.linearcollider.org/ILC/Publications/Technical-Design-Report>
- [2] J. Citadini, P. P. Sanchez, R. Basilio, M. Rocha, E.W. de Siqueira, M. Potye, and G. Tosin, Sirius—a 3 GeV electron storage ring based on permanent magnets, *IEEE Trans. Appl. Supercond.* Vol. 22, 4004404 (2012).
- [3] T. Watanabe, et al., “Permanent magnet based dipole magnets for next generation light sources”, *Phys. Rev. Accel. Beams*, vol. 20, p.072401 (2017)
- [4] T. Mihara, Y. Iwashita, M. Kumada, C. M. Spencer, “Variable Permanent Magnet Quadrupole”, *IEEE Trans. Appl. Supercond.*, vol. 16, 2, pp.224-227, (2006)