

TEST RESULTS FOR THE 201.25 MHZ TETRODE POWER AMPLIFIER AT LANSCE*

John T. M. Lyles[#], Steven Archuletta, Jerry Davis, Luis Lopez, Gabriel Roybal
Los Alamos National Laboratory, Los Alamos, NM, USA

Abstract

A new RF amplifier has been constructed for use as the intermediate power amplifier stage for the 201.25 MHz Alvarez DTL at the Los Alamos Neutron Science Center (LANSCE). It is part of a larger upgrade to replace the entire RF plant with a new generation of components. The new RF power system under development will enable increased peak power with higher duty factor. The first tank requires over 400 kW of RF power. This can be satisfied using the TH781 tetrode in a THALES cavity amplifier. The same stage will be also used to drive a TH628 Diacrode[®] final power amplifier for each of the three remaining DTL tanks. In this application, it will only be required to deliver approximately 150 kW of peak power. Details of the system design, layout for DTL 1, and test results will be presented.

DTL RF SYSTEM

The LANSCE proton linac provides a H⁺ beam of up to 17 mA peak and up to 800 MeV, with end applications such as medical isotope production at 100 MeV. The linac also accelerates H⁻ beam to a proton storage ring for charge accumulation for a spallation neutron source. Additional uses of the H⁻ beam from the linac are for weapons neutron research, semiconductor testing, proton radiography, and production of ultra-cold neutrons. Accelerating two beam species for these various applications requires high peak and average power from the 201.25 MHz DTL RF system. Three triode final power amplifiers (FPA) provide as much as 3 megawatts (MW) each at up to 12% duty factor (DF) for three of the Alvarez DTL tanks. A tetrode intermediate power amplifier (IPA) drives each FPA. A fourth system drives the first 5 MeV tank at approximately 400 kW, using exactly the same power tube lineup.

Recent improvements to the systems have reduced the number of electron power tubes in the DTL RF plant from fifty-two to twenty-four [1], with five different types in current use. New IPA and FPA stages are under development as replacements for the original amplifiers, which were installed 35 years ago [2]. Our goal is to reduce the number of power tubes in use to seven, with only two types used for the DTL. The new DTL RF plant would be able to deliver both peak power and high duty factor. This report describes work on a new IPA, which

can also be used as the FPA for the first DTL tank.

EXISTING INTERMEDIATE STAGE

A Burle Industries 4616 tetrode socketed in a RCA Y1068 cavity amplifier is presently used for the IPA, providing drive for a Burle Industries 7835V4 triode FPA. The 4616 tetrode was developed by RCA in 1958 [3][4], based upon their 6448 UHF television tetrode. It is rated for 30 kW anode dissipation, and has extremely high gain (18-20 dB) in grounded cathode operation. According to the datasheet, it can deliver 275 kW at 200-425 MHz with 6% DF. At LANSCE it delivers 120 kW to drive a 7835 triode in class B operation for DTL tanks 2 through 4.

Two 4616 tetrodes were originally used in 1970 to drive the first DTL tank [5], using a quadrature hybrid combiner without a circulator. There was much trouble operating the 4616 stages and two stages of smaller tetrode drivers, with matched phase and gain, while driving the resonant DTL load through the combiner. In 1974 one larger RCA 4664 tetrode was used to drive DTL 1. This configuration remained until 1987 when the tube was no longer available from the manufacturer. In 1988 the RF amplifier chain used for tanks 2 through 4 (4616→7835) was duplicated for tank 1, solving the combined amplifier problem. The anode and filament voltages of the 7835 FPA have been reduced to operate the amplifier at 15% of its normal output power.

NEW RF POWER AMPLIFIER

The TH781 power tetrode has been chosen to replace the 4616 tetrode IPA for the modernization program at LANSCE. Thales Electron Devices (formerly Thomson) demonstrated operation of the power tube at 200 MHz in 1996. It is a compact pyrolytic-graphite gridded tube, with multiphase (Hypervapotron[®]) anode cooling. It has a 250 kW maximum anode dissipation rating, and has operated in CW mode, as a driver for the Thales TH628 Diacrode[®] in the factory. At 200 MHz it can generate 200 kW CW or 500 kW at 1% DF.

A TH18781 cavity amplifier (fig. 1) was obtained from Thales. It uses water-cooling for the anode, the screen grid connection, and for the body of the cavity. It also uses air-cooling for the tube socket connections, the filament stem, parts of the cavity and output transmission line.

* Work supported by the United States Department of Energy under contract number W-7405-ENG-36.

jtml@lanl.gov

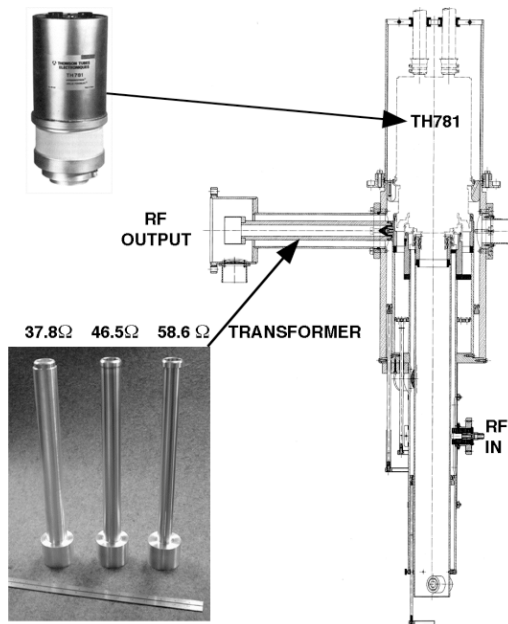

Figure 1: Amplifier tube and cavity with output transformer and three center conductors for matching

A compact TH781 linear amplifier was assembled and tested for our applications. Cooling system, power supplies and protective interlocks were incorporated using Allen Bradley Flexlogix programmable controllers. A 4616 tetrode power amplifier was used as a driver to provide the TH781 with up to 25 kW of input power. A high power coaxial output load was assembled using two 200 kW CW film resistor loads connected to a 3 dB hybrid power splitter.

Intermediate Power Amplifier Application

The TH781 was then tested with 16 dB of power gain, with sufficient output to cathode-drive an FPA at 120 to 150 kW. This is adequate for either the existing Burle Industries 7835V4 triode FPA or for a new Thales TH628 Diacrode® FPA under development at LANSCE [2]. The output matching of the amplifier is implemented using a series $\lambda/4$ coaxial line transformer, shown in figure 1. This length of 7.94 cm OD coaxial line transitions to a 15.56 cm OD flanged connector at 50 Ohms. In order to operate at the lower power levels efficiently with improved gain, the center conductor ID of the transformer was changed, to raise the impedance presented to the anode. The original transformer characteristic impedance was 37.8 Ω , and two additional transformers were constructed with $Z_0 = 46.5$ and 58.6 Ω . The low Z transformer is required when operating over 300 kW, to reduce the anode voltage swing at high power for best tube and cavity reliability.

Numerous tests were conducted with variations of operating parameters to obtain the best linearity, while maintaining acceptable efficiency and gain. The optimal results are shown in figures 2a and 2b. Anode voltage was

14 kV DC, and anode current was 6.4 Amps with no RF, and 24.4 Amps peak at 175 kW pulsed RF output.

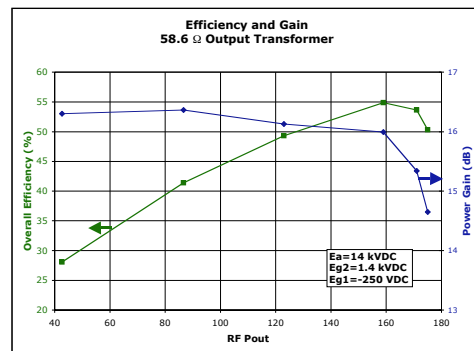
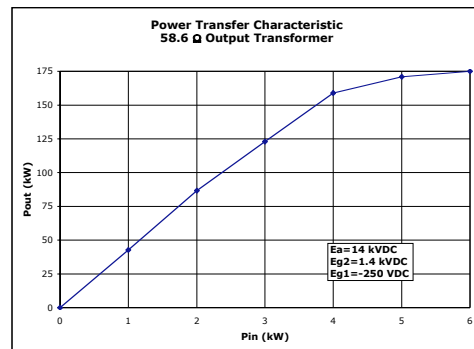

Figures 2a (top) and 2b (bottom): IPA Test

Final Power Amplifier Application

The new amplifier was also developed to be the prototype for a stand-alone amplifier with a 15.56 cm coaxial circulator to drive the first DTL tank in place of the existing 4616 IPA, 7835V4 FPA, and FPA anode modulator. Power requirements for this application are as follows, for the tank excitation alone and with the two highest beam currents expected:

| Tank 1 Energy Gain | P_{Cu} | $P_{Cu+18\text{ mA}}$ | $P_{Cu+21\text{ mA}}$ |
|--------------------|----------|-----------------------|-----------------------|
| 4.64 MeV | 305 kW | 389 kW | 403 kW |

Figure 3 shows the arrangement for the new RF station. The pulsed control grid bias and screen grid DC power supplies are not shown in this diagram.

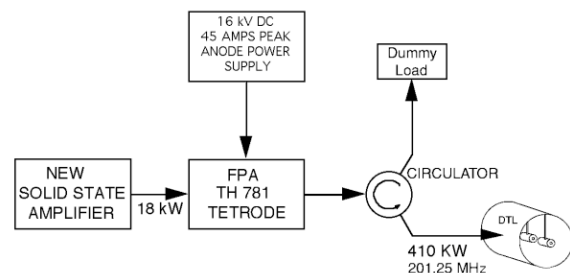
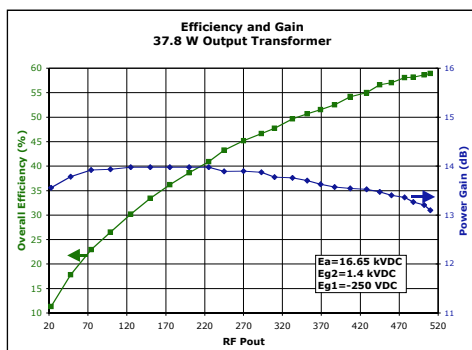
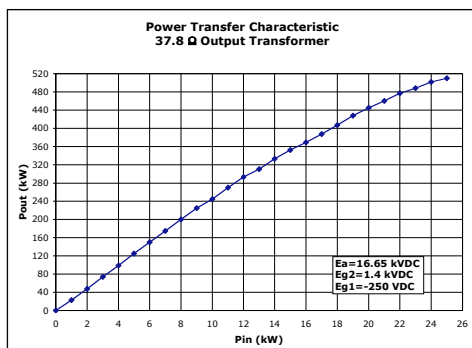

Figure 3: New RF System for DTL Tank 1 at LANSCE

The optimal high power test results are shown in the plots in figures 4a and 4b. Anode voltage was 16.5 kV

DC, and anode current was 7 Amps with no RF, and 44 Amps peak at 407 kW pulsed RF output. The maximum DF was 10% for this class AB₂ operating point.



Figures 4a (top) and 4b (bottom): FPA Test

Operating with 19 kV DC anode voltage raised the power gain from 13.5 dB to 14.8 dB, an advantage for the selection of a driver stage. However, this reduced the designed safety margin in the anode DC blocking capacitor, composed of wraps of 0.13 mm Kapton® film between the anode connector sleeve and the cavity wall. Considerable trouble was initially encountered with surface flashovers at the blocking capacitor, caused by an under-damped response, ringing at 400 KHz during the HV turn-on transient. The peak overshoot was then reduced from 33 to 22 kV by installing a series RC network at the cavity B⁺ terminal, and by a parallel RL network in series at the capacitor bank output terminal, impedance-matching the DC HV cable at both ends for high frequencies.

A novel method was used to adjust the amplifier for optimum linearity in real time, using the XY mode on a TDS784D digitizing oscilloscope. RF drive came from a signal generator, which was modulated with a pulsed linear ramp function. The input channels were connected directly to RF samples from input and output directional couplers, without using detectors. Both polarities of the RF cycle are displayed, resulting in symmetry seen in the display in figure 5. The more linear trace (red) results from operating with -250 volts control grid bias and the second (blue) trace with -350 volts bias. Screen voltage was 1.4 kV DC and anode voltage was 16.7 kV for both measurements. Note that the peak power (509 kW) is slightly higher for the second (blue) trace, but the gain is

lower (12.5 dB). The bend in the curve at low power is typical for a tetrode with reduced quiescent anode current.

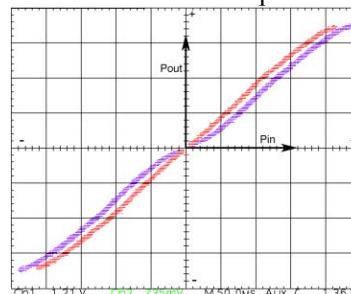

Figure 5: Linearity Test for Two Operating Points

RF DRIVER STAGE

There are two variations of driver/preamplifier required. The existing solid-state drivers at LANSCE are capable of 5.5 kW peak at 15% DF; these will be reused for the new IPA for DTL tanks 2 through 4. At DTL tank 1, however, a new solid state amplifier will be required, with a maximum output rating of 24 kW. This class AB₁ amplifier will be obtained commercially, using either NMR/MRI pulsed amplifiers or a modified version of a band IV television transmitter.

PROJECT SUMMARY

The Thales cavity amplifier and TH781 tetrode have been tested for two upcoming requirements at LANSCE. As an IPA to drive a future TH628 Diacrode® FPA with 120-150 kW, the amplifier provided over 16 dB power gain with 50% efficiency or better. As a stand-alone FPA to drive a 5 MeV Alvarez DTL tank, the amplifier provided 13.5 dB power gain with 50% efficiency or better. It can also be used to drive a 200 MHz RFQ in the future. Power supplies, driver amplifier and coaxial circulators are being specified for the complete installation.

REFERENCES

- [1] J. Lyles, C. Friedrichs, "LANSCE 201.25 MHz Drift Tube Linac RF Power Status," *Proc. International Linac Conference*, Geneva, 1996.
- [2] J. Lyles, S. Archuletta, G. Bolme, D. Clark, J. Davis, D. Keffeler, R. McCrady, "A New 201.25 MHz High Power RF System for the LANSCE DTL", *Proc. European Particle Accelerator Conference*, Paris, 2002, pp. 2329-2331.
- [3] W. Bennett, "New Beam Power Tube for UHF Service", *IRE Transactions on Electron Devices*, Jan., 1956, pp. 57-61.
- [4] M. Hoover, "Advances in the Techniques and Applications of Very High Power Grid-Controlled Tubes", *Proc. IEE*, v. 105, Part B, Suppl. 10, Nov. 1958, pp. 550-558.
- [5] R. Faulkner, T. Boyd, "LAMPF 200 MHz Power Sources", *Proc. Proton Linear Accelerator Conference*, Upton, NY, 1968, pp. 87-90.