

THE OPERATION OF DIGITAL BEAM POSITION MONITOR IN NSRRC

Changhor Kuo, Jenny Chen, K. H. Hu, Demi Lee, K. T. Hsu

National Synchrotron Radiation Research Center
101 Hsin-Ann Road, Hsinchu Science Park, Hsinchu 30077, Taiwan, R.O.C

Abstract

The digital beam position monitors are configured to operation system in the NSRRC now. This integration includes of multi-channel access, channel calibration, gain control, and parameter control to meet various operation condition, perform functionality and performance evaluation. The programmability nature of DBPM system is essential for multi-mode high precision beam position measurement. The system will support high performance beam position, turn-by-turn beam position, tune and other diagnostic measurements. Control system interface was implemented to support the operation of DBPM system. Various aspects will be discussed and presented in this report.

INTRODUCTION

An operation system of digital receiver based beam position monitor (DBPM) is implemented [1, 2]. The purpose of this system is used to the new technology for beam diagnostics application at the storage ring. The system composes a multi-channel coherent down-converter and a VME64x crate equips with multi quad-digital receivers boards (QDR). Preliminary results presents that the system achieved micron resolution in closed-orbit mode and high resolution in turn-by-turn mode.

achieve around 10 μm turn-by-turn resolution. The QDR consists of four symmetrical channels. The system block is shown in the figure 1. It consists of RF down convert, a band-pass filter, analogy-to-digital converter (ADC), digital down converter (DDC), FIFO memory and FPGA is for the data acquisition and control purposes.

The ADC is based on AD6644/6645. It is used for the analogy to digital conversion. This is a high speed, high performance, low power, and monolithic 14-bit analogy-to-digital converter. All necessary functions, including track-and-hold and reference are included on chip to provide a complete conversion solution.

The programmable DDC is composed of synchronization, input, input level detector, carrier mixer, CIC decimating filter, half-band decimating Filter, 255-tap programmable FIR filter, automatic gain control, Cartesian to Polar converter.

CONTROL SYSTEM INTERFACE FOR DBPM

The control system interface is separated to two layers. The embedded layer is VME64x crate with PowerPC module running the real time operation system of LynxOS. The user interface layer is located at workstation/Unix and PC/Linux control console, support commercial software Matlab and LabVIEW. The VME host receives control parameters from user interface by Ethernet. The control parameters include that change operation mode either turn-by-turn mode or closed orbit mode, adjust FIR filter coefficient and decimation factor of system. The data of DBPM is replied to user interface after receive software trigger from Ethernet. The software environment is shown in the figure 2. The DBPM is seamless integrated with the existing system.

There are two threads in the VME host. One is setting thread that handles all parameter control, such as turn-by-turn mode and close orbit mode control parameters update. Another is reading thread that handles control status response and data access of DBPM. All data and control parameter are collected in the share memory. The closed orbit data is sent to a dedicated BPM server node by reflective memory network. The update rate of closed orbit beam position is 1 KHz in the orbit feedback reflective memory network. The VME host of the BPM server down sampled the closed orbit data to 10 Hz and update to dynamic database in all control consoles.

The data of DBPMs in turn-by-turn mode are directly served to client running on control console via control

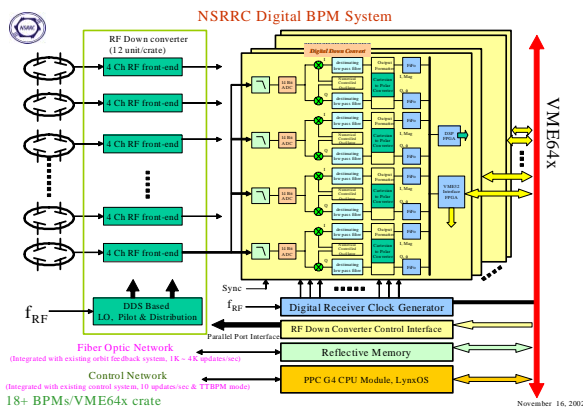

Figure 1: System block diagram of the digital BPM.

The digital BPM electronics are commercial products [3]. The electronics consist of two parts, the first parts is 4 channels RF down converter that convert 500 MHz beam signal into intermediately frequency (20 MHz) coherently. Four signals of IF are digitized and processed by quad-digital receiver boards. The resolution of averaged beam position measurement can be better than one micron and

Ethernet. The input rate of DBPM is 50 MS/s. The output rate is 2.5 MS/s after CIC, half-band and FIR filter. The CIC decimation factor is 5, half-band decimation factor is 2 and FIR decimation factor is 2. BPM acquisition is started after accepts event from client. Position calculation is done after the FIFO of DBPM is full. The maximum depth of FIFO is 8192 long words in each channel. The maximum record time is 3.2 milliseconds in the turn-by-turn mode.

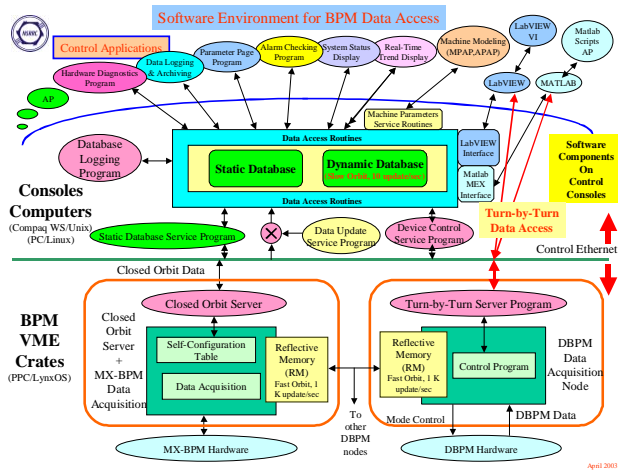

Figure 2: Software environment for BPM data access.

SYSTEM PERFORMANCE

Preliminary beam test was done recently. The installed BPMs will join the routine operation in near future. To examine the closed orbit performance, short-term and long-term test is underway. The long-term stability can be achieved ~ μm level with 1KHz output rate that is comparative with existing orbit feedback system. The resolution can be better after optimized the parameters of digital receiver. The long-term performance of DBPM is shown in the figure 3. The RMS resolution of DBPM is less than 1 μm with 1 KHz update rate.

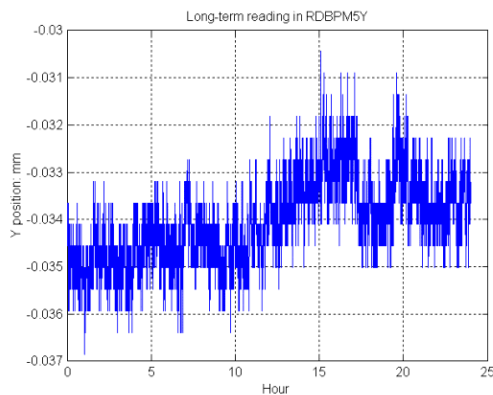

Figure 3: Long-term stability in the closed orbit mode with 1 KHz output rate.

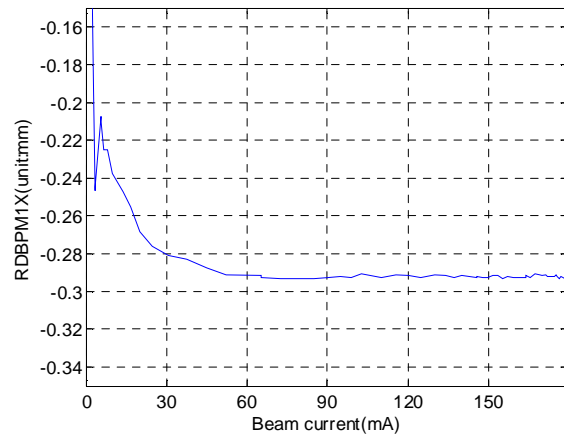

Figure 4: The dynamic range of DBPM.

The dynamic range of DBPM measurement is shown in the figure 4 with the real beam. The beam intensity is reduced from 179 mA by scrapper of storage ring. The position is shifted 20 μm , when beam current is downed to 20 mA.

The revolution frequency of the storage ring of NSRRC is 2.5 MHz. The turn-by-turn BPM electronics have 1.25 MHz bandwidth is essential in principle. However, the fractional tune of the storage ring is less than 0.33; bandwidth of 0.8 MHz is enough to support the measurement. The preliminary turn-by-turn parameter set achieves 0.8 MHz bandwidth (-3 dB) at this moment as shown in figure 5. The investigation is going how to increase bandwidth by optimize the parameters of digital receiver. Adopt data post processing to compensate the frequency response to increase the bandwidth is another alternative solution.

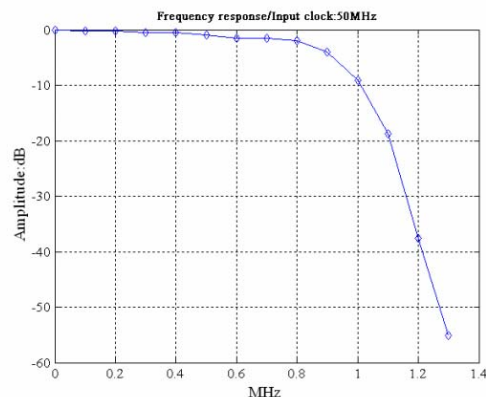

Figure 5: Bandwidth of DBPM system for turn-by-turn mode.

To demonstrate the functionality of the turn-by-turn mode, various testing have been done recently. Figure 6(a) presents the data of a BPM in frequency domain with horizontal kick. Betatron oscillation is clearly observed by the output of DBPM. Figure 6(b) shows the data of a BPM in frequency domain with vertical kick. Figure 5 shows a single button reading in the time domain of DBPM with ~ 1 mrad horizontal kick by an injection kicker, the horizontal betatron oscillation is excited.

The turn-by-turn beam position in for one DBPM is shown in the figure 7 when the RF gap voltage modulation is turned on. The RF gap voltage modulation is used to remedy the strong longitudinal coupled bunch instability right now. The beam was excited by narrow band white noise, both horizontal and vertical betatron oscillation are excited. The top figure is the signal picked up by a single button. The prominent sinusoidal signal is induced by the RF gap voltage modulation. Turn-by-turn beam position is calculated by using four button signals. The horizontal position is ride on the 50 kHz of background that is shown in the middle figure. This background is due to un-calibration of the four button processing chain. Parallel processing electronics are insensitivity to the longitudinal instability in the principle. The background can be minimized after applied proper calibration correction. Bottom figure is the vertical position shown clean betatron oscillation. The phase space measurement by two BPMs with horizontal phase advance near $\pi/2$ is shown in the figure 8. The difference colour dots define various groups of turns.

turn-by-turn resolution is better than 10 μm . Upper: single button signal; Middle: un-calibrated horizontal position; Bottom: un-calibrated vertical position.

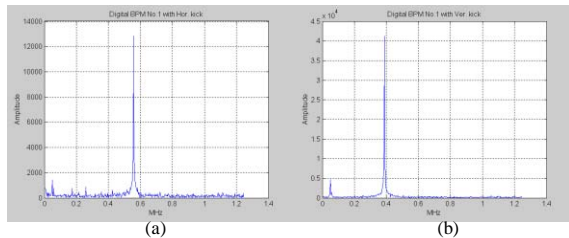

Figure 5: (a) The frequency domain of digital BPM with horizontal kick, (b) with vertical kick.

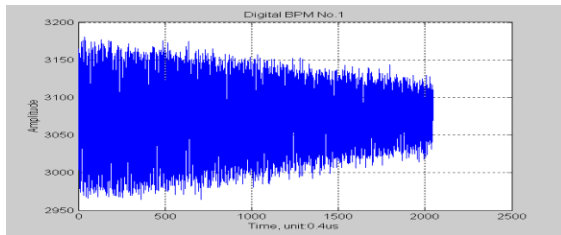

Figure 6: Damped horizontal betatron oscillation observed by a single button of BPM.

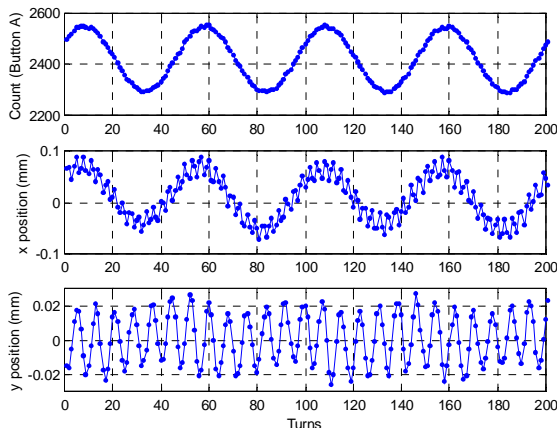

Figure 7: Preliminary results of the DBPM shown that the

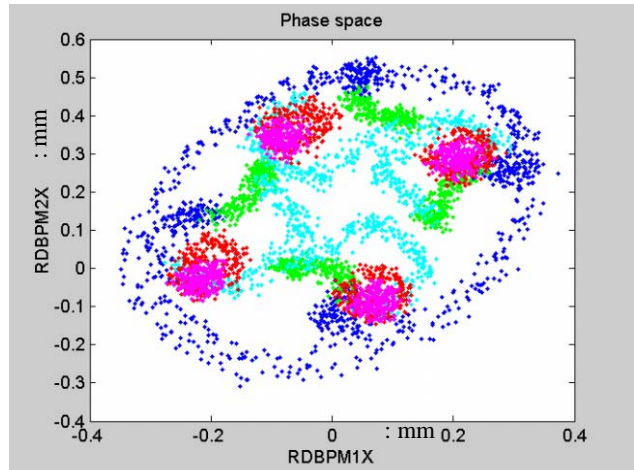

Figure 8: Phase space near 4th order resonance, blue dot: 1 to 1000 turns, green dot: 1001-2000, cyan dot: 2001-3000, red dot: 3001-4000, magenta dot: 4001-5000.

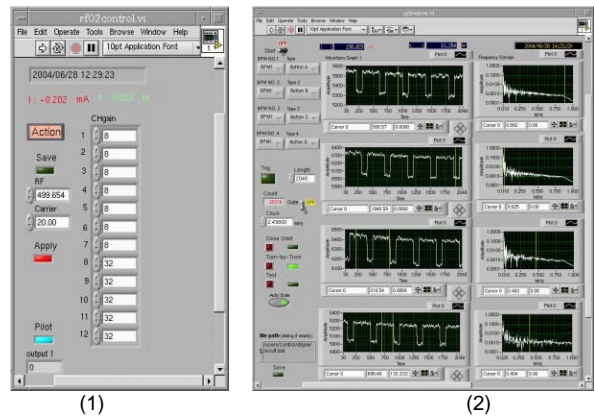

Figure 9: (1) Gain and pilot control user interface, (2) Diagnostic tool of DBPM user interface.

The integrated user interface for gain and pilot control is shown in the figure 9.1. The diagnostic tool of DBPM is shown in the figure 9.2. These software are developed in the Linux system to support immediately control and calibration of DBPM with VME master. The four channel gains of DBPM are set to the same, but difference software ratio will be calculated to take more high precision calibration after pilot procedure.

REFERENCES

[1] M. Dehler, et al., "Digital BPM System for the Swiss Light Source – First Operation Results", AIP Conference Proceedings 546, 572 (2000).
 [2] V. Schlott, et al., "First Operational Experience with the Digital Beam Position Monitoring System for the Swiss Light Source", Proceeding of EPAC 2000, Vienna, Austria, 1809 (2000).
 [3] <http://www.i-tech.si/products-dbpm2-p.htm>.