

USING VISIBLE SYNCHROTRON RADIATION AT THE SLS DIAGNOSTICS BEAMLINE

V. Schlott, M. Dach, C. David, B. Kalantari, M. Pedrozzi, A. Streun, PSI, Villigen, Switzerland

Abstract

A diagnostics beamline has been set-up at the BX05 bending magnet of the SLS storage ring. It makes use of a large range of the synchrotron radiation spectrum for measuring SLS beam parameters. The visible part of the dipole radiation is transported to an optical lab, where the temporal profile of the storage ring bunches can be measured with a minimal time resolution of 2 ps using a dual sweep, synchrocan streak camera. A fast avalanche photo diode (APD) has been set up in parallel to monitor the filling pattern of the storage ring. Beam size and coupling is intended to be measured with a zone plate monitor at 1.8 keV photon energy overcoming diffraction limitations. This paper describes the beamline design and summarizes the first experimental results with visible synchrotron radiation.

BEAMLINE DESIGN

The DB diagnostic beamline has been built up in sector 5 of the SLS TBA lattice at the BX05 central bending magnet. It has been designed to allow the use of synchrotron radiation over a broad spectral range from many keV to the visible part of the spectrum. The source point of the synchrotron radiation is located at 400 mm in front of the bending magnet center. The DB-front end radiation port accepts maximum opening angles of ± 3.5 mrad vertically and ± 5.5 mrad horizontally. Two staggered pair blade type photon beam position monitors (PBPM) [1] are located in the inner side of the front end at 4.2 m and 7.2 m from the source point providing vertical position and angular information of the photon beam. A pinhole array monitor [2] on the outer side of the front end allows observing beam profiles with limited spatial resolution of about 30 μm . The visible part of the synchrotron radiation is coupled out of the front end in the X05 optics hutch using a water cooled copper mirror, which is placed under 45°. An optical transfer line with

100 mm diameter transports the visible radiation onto an optical table in the experimental hutch. The high energy part of the synchrotron radiation can pass the cooled copper mirror through a central hole of 5 mm diameter towards a zone plate monitor, which is set up to measure the transverse beam profile with high resolution using 1.8 keV radiation [3].

EXPERIMENTAL HUTCH

The visible part of the synchrotron radiation arrives through an optical chicane onto an optical table in the experimental hutch of the X05DB diagnostic beamline. The radiation is collimated by use of an achromatic telescope optic and distributed to several selectable experimental stations on the optical table. In addition to permanent setups, it is thus also possible to develop and interface optical diagnostics for later installation in the storage ring tunnel.

Streak Camera Setup

A permanent setup transfers the light to the Optoscope [4] - a dual sweep, synchroscan streak camera system, which is equipped with one fast (horizontal) and two selectable slow (vertical) time bases. The 250 MHz, fast deflecting time base of the streak camera is synchronized to the 500 MHz of the SLS storage ring RF allowing the measurement of the longitudinal profile of each individual electron bunch in the storage ring with a minimum temporal resolution of 1.8 ps. The corresponding streak images can be projected on the second, slow time bases, which are ranging between 10 ns and 10 ms. The finite temporal resolution of the system is limited by dispersion of the photo-electrons in the streak tube and the jitter of the deflecting voltage. Since the dispersion of the photo-electrons is larger for UV-light, leading to a degraded time resolution of 3 ps, the best results can be obtained by use of monochromatic light (< 10 nm bandwidth) at wavelengths > 400 nm [5]. Thus, an adequate band-pass

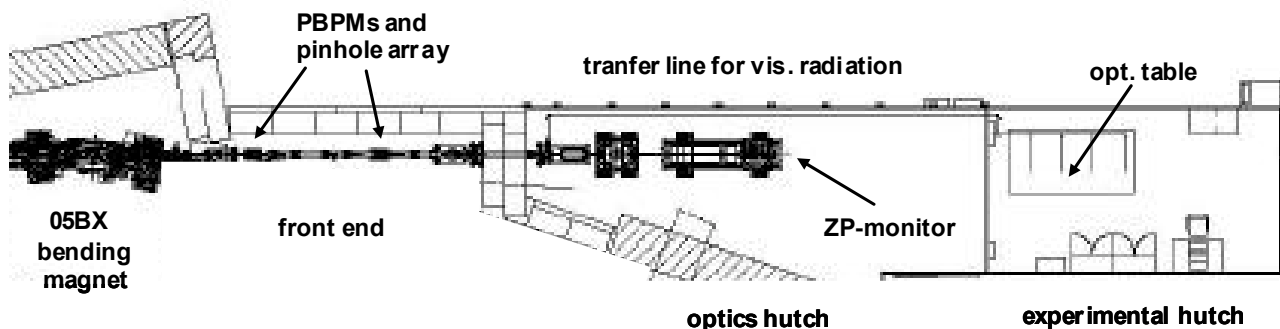

Figure 1 : SLS diagnostic beamline at 05BX bending magnet. The layout shows the generic front end with photon beam position monitors and pinhole array, the optics hutch with the zone plate profile monitor and the experimental hutch with an optical table for experiments with visible synchrotron radiation.

filter at 650 nm is usually put in the beam path to the streak camera.

Filling Pattern Monitor

The streak camera setup can be bypassed by insertion of a tilting mirror to reflect the light onto an avalanche photo diode (APD) of type AD230-8-TO52-S1 [6]. A schematic setup of both experiments is shown in Fig. 2.

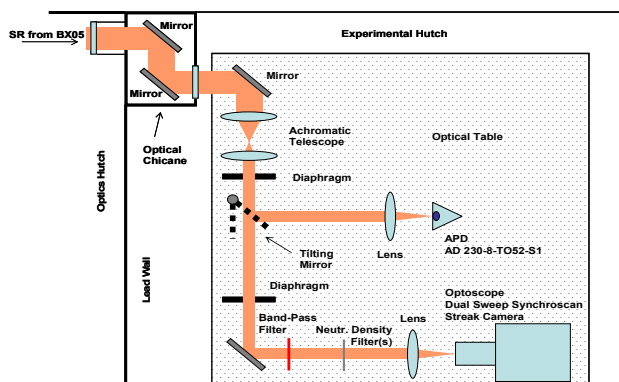

Figure 2: Schematic setup of streak camera and filling pattern measurements on the optical table in the experimental hut of X05DB diagnostic beamline.

The APD has an active area of 0.042 mm² (230 μm diameter) with maximum spectral responsivity between 700 nm and 800 nm. Due to its low capacitance (1.5 pF), it provides fast rise times (typ. 180 ps) with high gain at comparatively low bias voltages (typ. 165 V). The diode fully resolves single electron buckets in the storage ring, which have a bunch spacing of 2 ns (500 MHz) at bunch charges as low as 100 pC. The left side of Fig. 3 shows part of the SLS filling pattern in the so called “cam shaft” mode [7], where a single electron bunch is placed in the middle of a gap between two revolutions. The right side of Fig. 3 gives an indication of the time resolution of the APD showing the single bucket with a width of about 200 ps FWHM.

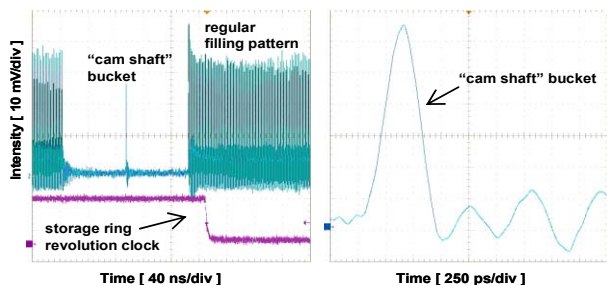

Figure 3: APD measurements of “cam shaft” mode in SLS storage ring (left) and single “cam shaft” bucket (right) performed with Tektronix TDS 7704B digital phosphor oscilloscope at 7 GHz analogue bandwidth and 10 GS/s.

A filling pattern feedback [8] has been successfully implemented, keeping the filling pattern of the SLS storage ring even to a level of a few percent under top-up operating conditions.

STREAK CAMERA MEASUREMENTS IN CAMSHAFT MODE AND TRANSIENT BEAM LOADING EFFECTS

An 18.7% gap in the SLS storage ring filling pattern is commonly used to suppress ion trapping instabilities. In a so called “camshaft mode” we benefit from this circumstance by filling one single bucket within the gap, which is used for time resolved X-ray experiments without perturbing the normal users. The camshaft bunch length is directly related to the temporal resolution at the experiment and depends on the transient beam loading effects in the SLS RF super conducting third harmonic system. A description of this Landau cavity used for bunch lengthening and the improved life time as well as beam stability can be found in [9].

Due to the limitations of the analytical models, the transient beam loading effects in storage rings with harmonic system has been recently studied with the help of tracking codes [10]. Those studies and the experimental results as shown in figure 4 clearly indicate that the maximum lengthening achievable strongly depends on the filling pattern profile.

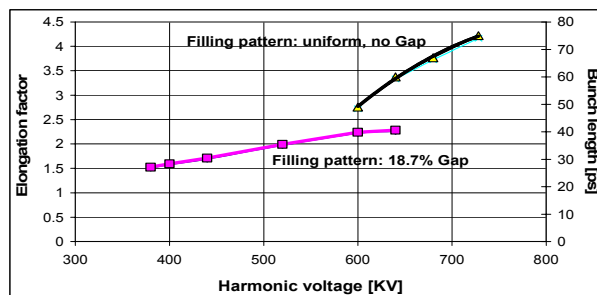

Figure 4: Streak camera measurement, average bunch length in the SLS storage ring with 300 mA uniform filling pattern and with 18.7% empty gap.

Figure 5a shows a streak camera snap shot of one turn in the storage ring, with a camshaft bucket of 1mA placed 90 ns from the head of the bunch train (390 buckets). The simulations as well as the experimental results show, that the zero phase drift with respect to the synchronous phase (Fig. 5b and 5c) which is optimum for bunch lengthening occurs approximately in the middle of the bunch train and it is maximum (here ± 16 deg) at its extremes. As demonstrated by the non linear simulations [10] the harmonic voltage can fluctuate as well, especially in the case of a normal conducting systems, going trough a minimum approximately in the center of the train and remaining somewhat constant along the gap. In the SLS case the behavior of the camshaft bunch depends mainly on its position with respect to the synchronous phase. Since the phase drift of the 3rd harmonic cavity is varying linearly along the gap we can expect a maximum bunch lengthening in the middle of the gap with the phase crossing zero. The streak camera measurements (300 mA average current - 40% gap) summarized in figure 5b and 5c for two position of the camshaft bunch confirms these considerations.

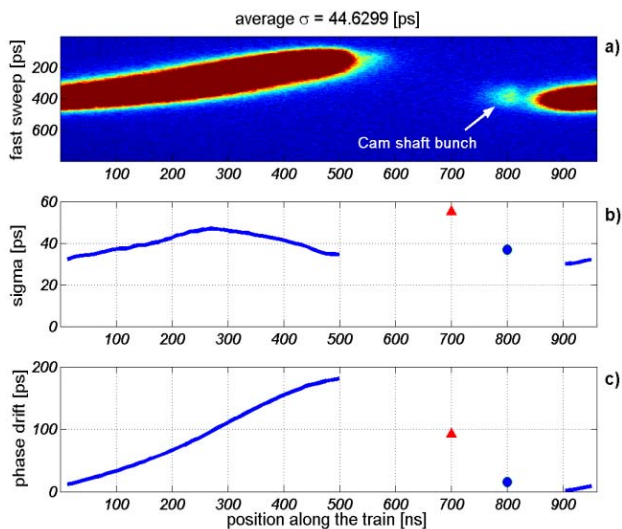

Figure 5: a) Streak camera snap shot with 40% gap in the filling pattern and a camshaft bucket at 90 ns from the train tail. b) 1σ bunch length along the train and for a centered (triangle) and non centered (circle) camshaft bucket. c) Phase drift with respect to synchronous phase. The camshaft bucket in the middle of the gap (at zero crossing) experiences largest lengthening.

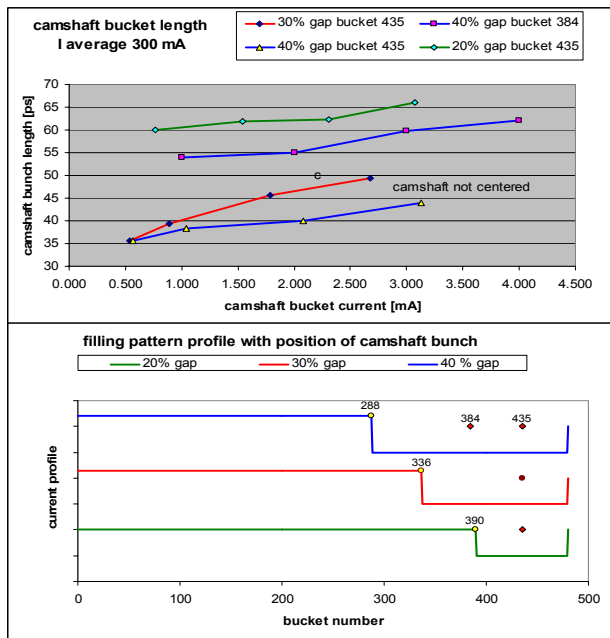

Figure 6: (top) length of the camshaft bucket for different filling pattern configurations. (bottom) filling pattern profiles (continuous line) and location of the camshaft buckets (diamonds) during the streak camera measurements.

Figure 6 summarizes the bunch length measurements for the camshaft bucket versus its current made with 3 different gaps. The usual SLS filling pattern of 390 filled buckets and centered cam shaft bucket seems to be less favorable for time resolved X-ray measurements.

However, these first results indicate considerable margin for improvement. Further measurements are presently needed in order to find a better compromise satisfying the “normal” SLS users and the requirements for time resolved measurements.

In addition, streak camera measurements were performed with single bunches in the storage ring at increasing beam currents. The results (see Fig. 7) show an indication for turbulent bunch lengthening for threshold currents above 1.2 mA in agreement with previous measurements based on Touschek lifetime [11].

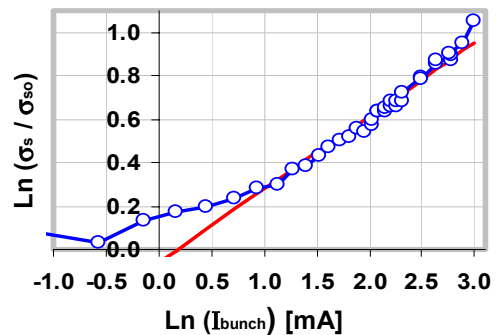

Figure 7: Relative rms bunch length σ_s/σ_{so} vs. single bunch current I_{bunch} in logarithmic scale. Fitting a straight line gives a scaling with exponent of $0.34 (\pm 0.01)$ and a threshold current of $1.2 (\pm 0.2)$ mA.

REFERENCES

- [1] K. Holldack, W.B. Peatman, “Synchrotron Radiation Diagnostics on BESSY II”, AIP Conf. Proc. 521 (1999) 354.
- [2] K. Holldack, J. Feikes, W.B. Peatman, “Review of Emittance and Stability Monitoring using Synchrotron Radiation Monitors”, DIPAC’01, Grenoble, May 2001, p. 16.
- [3] C. David, V. Schlott, ”A Zone Plate based Beam Monitor for the Swiss Light Source”, DIPAC’01, Grenoble, May 2001, p. 133.
- [4] See webpage: <http://www.optronis.com>
- [5] P. Summ (Optronis company), priv. communication
- [6] See webpage: <http://www.silicon-sensor.de>
- [7] B. Kalantari, T. Korhonen, A. Lüdeke, C. Quitmann, “Enhancements of Top-up Operation at the Swiss Light Source”, these proceedings.
- [8] B. Kalantari, T. Korhonen, V. Schlott, “Bunch Pattern control in Top-up Mode at the SLS”, these proceedings.
- [9] M. Pedrozzi et al, “First operational results of the 3rd harmonic superconducting cavities in SLS and ELETTRA”, PAC’03, Portland Oregon (2003), p878.
- [10] J.M. Byrd, S. De Santis, J. Jacob, V. Serriere, “Transient beam loading effects in harmonic rf systems for light sources”, Phy. Rev. Special Topics, Vol 5, 092001 (2002).
- [11] A. Streun, “Beam Lifetime in the SLS Storage Ring”, Int. Rep. SLS-TME-TA-2000-191, PSI Dec.200