

# DIAGNOSTICS OF INSTABILITIES AT BESSY II USING THE DIGITAL LONGITUDINAL FEEDBACK SYSTEM\*

S. Khan, BESSY, Berlin, Germany

## Abstract

The digital recording capability of the longitudinal feedback system at BESSY II can be used to study longitudinal modes as well as transverse instabilities below the longitudinal instability threshold. Results from longitudinal, horizontal and vertical multibunch oscillations are discussed.

## 1 INTRODUCTION

In 1999, bunch-by-bunch feedback systems to counteract multibunch instabilities were installed and commissioned at BESSY II, a 3rd-generation synchrotron radiation source in Berlin [1] [2]. The digital longitudinal feedback system (LFB) was originally developed for use at the ALS/Berkeley, at PEP-II/Stanford and DAΦNE/Frascati, with later installations at the PLS/Pohang, at SPEAR/Stanford and BESSY-II. An overview of its architecture and capabilities is given elsewhere, e.g. [3]. The analog transverse feedback system (TFB) is similar to that of the ALS [4]. Both systems have been in routine operation since 1999 and have significantly improved the quality of synchrotron radiation delivered to the users. Moreover, they have been used as diagnostics tools to obtain information on multibunch instabilities and other impedance-related issues such as synchronous phase transients.

The LFB digitizes the longitudinal dipole moment at a rate of 500 MHz. Downsampled data are passed to an array of 40 digital signal processors (DSPs) generating a correction signal which is then applied to the beam using a kicker cavity. Without interrupting the operation of the system, about 1400 measured values for each of the 400 bunches can be read from a dual port memory. With a sampling rate of 35-45 kHz, a time interval of 30-40 ms is covered, corresponding to 4-5 longitudinal damping times. As shown schematically in figure 1, the DSPs switch at an adjustable time  $t_0$  prior to data recording from a digital filter #0 to a second filter #1 and switch back to filter #0 at  $t_1$  during data acquisition. Usually, the two filter algorithms differ only by an overall gain factor  $g_0$  and  $g_1$ , respectively. Typical configurations are:

- $g_0 = 0, g_1 = 0$ : unstable beam is recorded
- $g_0 > 0, g_1 = g_0$ : stable beam is recorded
- $g_0 > 0, g_1 = 0$ : instabilities are allowed to grow
- $g_0 > 0, g_1 = -g_1$ : instabilities are actively excited.

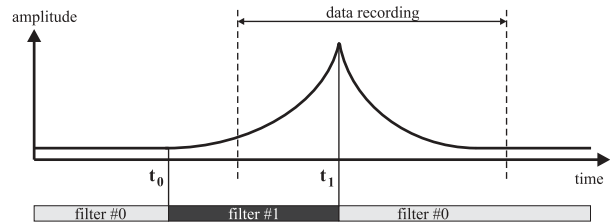

Figure 1: Diagram of LFB data acquisition during which the system switches between two filter algorithms.

Applications, where instabilities are allowed to grow or excited and subsequently damped by the feedback, are commonly referred to as "grow-damp" measurements.

The TFB, being a purely analog system, is lacking data recording capabilities, but information on transverse motion can nevertheless be accessed using external devices such as a digital oscilloscope, a spectrum analyser, or – as discussed below – the LFB. The functionality of the LFB as data recording device exceeds that of traditional diagnostics tools since time, frequency and phase information is available simultaneously.

## 2 RESULTS

### 2.1 Longitudinal Instabilities

Grow-damp measurements are extremely useful to examine the feedback performance (e.g. the damping rate, resistive and reactive response) and to study the growth rates and modal content of instabilities. Figure 2 shows a typical example, where the oscillation amplitude is plotted versus time and bunch number (left) and – after a Fourier analysis – versus mode number (right). Damping rates of the order

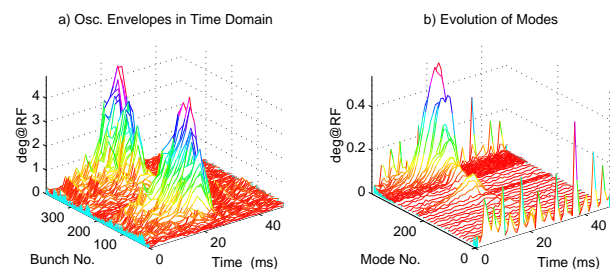

Figure 2: Longitudinal grow-damp measurement. The oscillation amplitude is plotted versus time and bunch number (left) and versus time and mode number (right).

\* Funded by the Bundesministerium für Bildung und Forschung and by the Land Berlin.

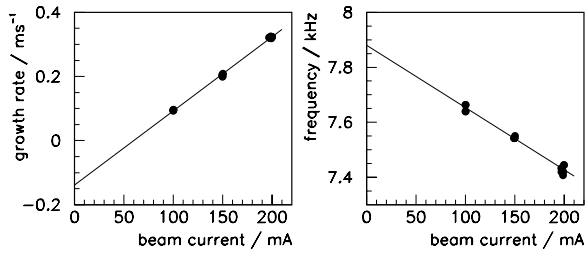

Figure 3: Growth rate (left) and oscillation frequency (right) of the longitudinal multibunch mode 240 as function of the beam current.

of  $1000 \text{ s}^{-1}$  are observed, depending on the particular gain setting. In the case shown here, the storage ring was operated with two bunch trains. The excited eigenmodes of this pattern are combinations of the even-fill eigenmodes assumed in the modal analysis of the data, and are centered at the even-fill eigenmode 240 excited by a higher-order mode (HOM) of a 3rd-harmonic cavity at 2.3 GHz (BESSY II uses four passive cavities for bunch-lengthening to increase the Touschek beam lifetime).

In another measurement, the storage ring was filled "evenly" (with  $< 10\%$  variation of the bunch current) with a much cleaner mode spectrum. The measured growth rates  $1/\tau$  and oscillation frequencies  $f$  of mode  $\mu = 240$  are shown in figure 3 as function of beam current  $I$ . The slope of the graphs can be used to determine the complex impedance  $Z_{\parallel}(\omega')$  assuming a single contribution at  $\omega' = p h \omega_o + \mu \omega_o + \omega_s$ , where  $p$  is an integer,  $h$  is the harmonic number,  $\omega_o$  is the revolution frequency and  $\omega_s$  is the synchrotron frequency [5]:

$$\frac{\Delta f}{\Delta I} + i \frac{\Delta(1/\tau)}{\Delta I} = \frac{\eta \omega_o}{8\pi^2 \omega_s E/e} \omega' Z_{\parallel}(\omega'), \quad (1)$$

where  $E/e$  is the beam energy in eV and  $\eta$  is the slippage factor. With the independently observed HOM frequency of 2.3 GHz ( $\omega' = 1600 \omega_o + 240 \omega_o + \omega_s$ ), the result is

$$Z_{\parallel}(\omega') = (121 \pm 8) \text{ k}\Omega - i(166 \pm 11) \text{ k}\Omega. \quad (2)$$

The extrapolation of  $1/\tau$  to zero current, which is compatible with the longitudinal damping rate, is an indication that no systematic error (e.g. frequency shift of the HOM between measurements) occurred. If more than one mode is excited, their oscillation frequencies should coincide at  $I = 0$ , as is the case in the BESSY data shown in [5].

Observation of the stable beam yields valuable information on the synchronous phase of each bunch. While the LFB measures a dipole moment (current  $\cdot$  phase), rf noise common to all bunches can be used to disentangle current and phase. With a gap in the bunch pattern, the synchronous phases reflect the wake fields sampled at the bunch spacing, as shown in figure 4, where the LFB result is compared to streak camera data (top). The slope results from beam loading in the main and harmonic cavities while

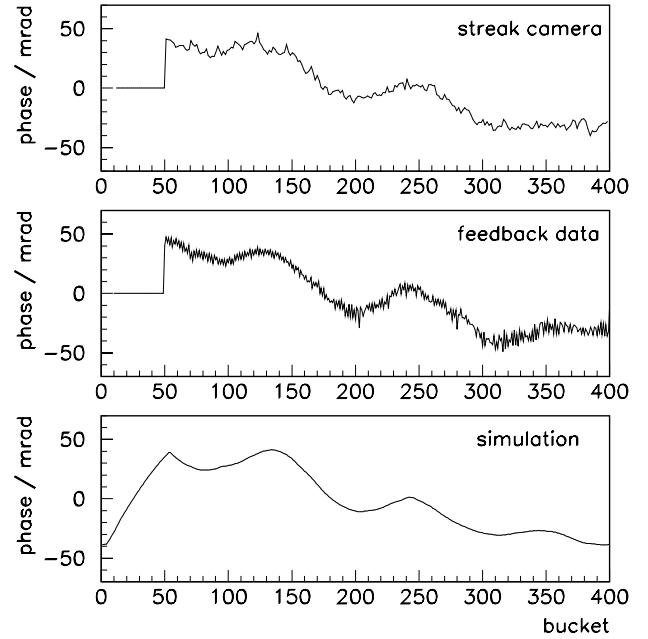

Figure 4: Synchronous phase angle versus bucket number, extracted from a streak camera image and from LFB data, and predicted by a beam loading simulation.

the oscillation with a period of  $\sim 100$  buckets is produced by two 3rd-harmonic cavities "parked" at  $3 \omega_{\text{rf}} - 3.5 \omega_o$ . In addition to confirming these conclusions by a simulation as shown in figure 4 (bottom), the impedance can also be calculated directly from the synchronous phases [6].

Another application of the LFB as diagnostics tool is phase space tracking, where the time evolution of modal amplitude and phase space angle is studied, which gives e.g. insight in the dynamics of uneven-fill modes [7].

## 2.2 Transverse Instabilities

The LFB was used to record transverse beam motion detected by the TFB receivers, while a GaAs switch was used to interrupt the signal to the transverse feedback kicker, as shown in figure 5. These transverse grow-damp measurements were restricted to beam currents below  $\sim 80$  mA where the beam was longitudinally stable and the LFB was not required.

Figure 6 shows a measurement of a horizontal instability with an apparent mode number of 399, where the integer part of the betatron tune was ignored in the analysis. Vertical grow-damp measurements are similar in appearance except that the growth rates are larger by a factor of two and that non-exponential behavior may introduce a systematic uncertainty for the measured growth rates. Figure 7 shows growth rates and tune shifts as function of current for the horizontal and vertical case. A positive tune shift in the horizontal and negative tune shift in the vertical plane is typical for the resistive-wall effect in vacuum chambers where the horizontal aperture is larger than the

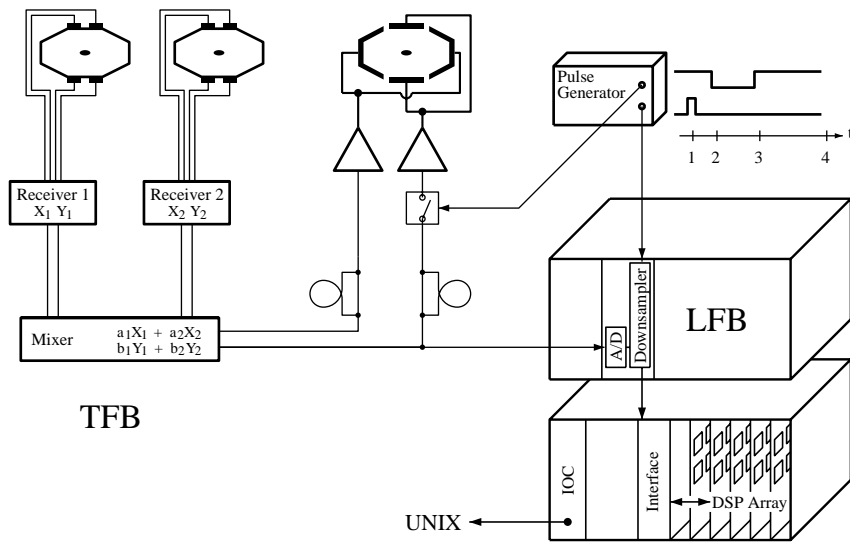

Figure 5: Experimental setup for grow-damp measurements of transverse instabilities. A pulse generator simultaneously interrupts the signal to the TFB kicker and triggers the LFB to record digitized data.

vertical gap [8] [9]. The impedance cannot be concluded in a straightforward manner as in equation 1 because it rolls off as  $\sim \sqrt{1/\omega}$  and many frequencies contribute to the result. The wake field can be calculated numerically for a general vacuum chamber cross section [10], but the calculation of growth rates is known to fail unless diffusion of the magnetic field is taken into account [8]. Usually, no transverse instability other than caused by the resistive-wall effect is observed at BESSY II, but one experiment following a shutdown period, where the vacuum was poor, revealed additional transverse modes that resembled ion-related phenomena observed elsewhere [11].

### 3 ACKNOWLEDGEMENTS

The continuous support by the SLAC feedback group is gratefully acknowledged. Setting up the transverse measurements would not have been possible without the help of D. Teytelman (SLAC). Most of the data analysis software was written by him and by S. Prabhakar (SLAC).

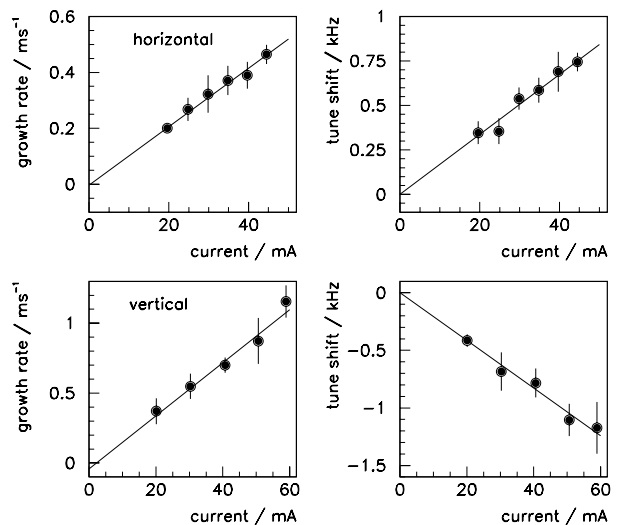

Figure 7: Horizontal (top) and vertical (bottom) growth rates (left) and tune shifts (right) as function of current.

### 4 REFERENCES

- [1] S. Khan et al., EPAC 2000, Vienna (2000), 1903.
- [2] T. Knuth et al., EPAC 2000, Vienna (2000), 1912.
- [3] D. Teytelman et al., SLAC-PUB-8417 (2000).
- [4] W. Barry et al., PAC 1995, Dallas (1995), 2423.
- [5] D. Teytelman et al., Phys.Rev.STAB 4 (2001), 112801.
- [6] S. Prabhakar et al., SLAC-PUB-7979 (1998).
- [7] S. Prabhakar et al., Phys.Rev.STAB 2 (1999), 084401.
- [8] S. Heifets, SLAC-PUB-7985 (1998).
- [9] R. Nagaoka, PAC 2001, Chicago (2001), 3531.
- [10] K. Yokoda, Part. Acc. 41 (1993), 221.
- [11] S. Heifets, D. Teytelman, SLAC, priv. comm. (2002).

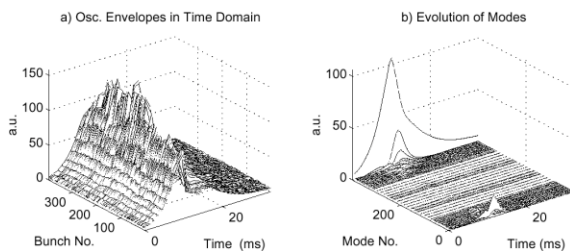

Figure 6: Horizontal grow-damp measurement. The oscillation amplitude is plotted versus time and bunch number (left) and versus time and multibunch mode number (right).