

SINGLE SPOKE CAVITIES FOR LOW-ENERGY PART OF CW LINAC OF PROJECT X

I. Gonin, M. Champion, T. Khabiboulline, A. Lunin, N. Perunov, N. Solyak, V. Yakovlev, Fermilab, IL 60510, U.S.A.

Abstract

In the low-energy part of the Project X H-linac three families of 325 MHz SC single spoke cavities will be used, having $\beta = 0.11, 0.21$ and 0.4 . Single spoke cavity was selected for the linac because of higher r/Q . Results of optimization of all cavities are presented. Results of the beam dynamics optimization for initial stage of the linac with $\beta=0.11$ single spoke cavity are presented at poster MOPEC082 (this conference).

INTRODUCTION

Project X is currently in the R&D phase awaiting CD-0 approval. During last few years a series of machine configurations were developed. One of them (ICD-1) was a pulsed 8 GeV 20 mA H-linac based on ILC type cavities [1]. An alternative scheme [2] of the Project X proton source (ICD-2) is based on the 3 GeV CW superconducting linac that accelerates beam with the current of 1 mA, see Figure 1.

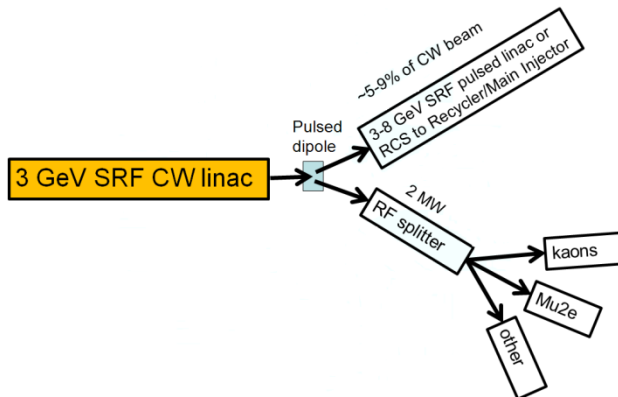

Figure 1: Project X configuration.

The beam originates from a DC H^- source. The beam is then bunched and accelerated by a CW normal-conducting RFQ to 2.5 MeV and the bunches are formatted by a chopper following a pre-programmed timeline. From 2.5 MeV to 3 GeV the H^- bunches are accelerated by a CW super-conductive linac. A present concept of the linac is based on the 8 GeV pulse linac design, including designs of cavities, cryomodules and beam optics (to the extent possible). The CW, 3-GeV linac has an average current (over few microseconds) of 1 mA, with a pulsed current of up to 10 mA. Since the pulsed 8-GeV Project X linac (ICD-1) has a well developed optics operating at this current range, it is possible to use the same structure of the linac and same break points as in the pulsed linac with the necessary modifications to operate in a CW regime.

GENERAL

The CW linac (see Figure 2) consists of a low-energy 325 MHz SCRF section (2.5 - 160 MeV) containing three different families of single-spoke resonators (SSR0, SSR1, SSR2) having $\beta = 0.11, 0.21$ and 0.4 , two families of 650 MHz elliptical cavities having $\beta = 0.6, 0.9$ (160 MeV - 2 GeV), then 1300 MHz ILC-type $\beta = 1$ cavities the high energy SCRF section (2 GeV - 3 GeV).

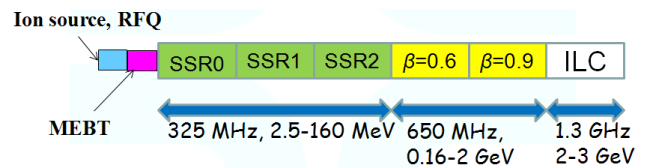

Figure 2: Configuration of Project X based on CW linac.

The major modification in the low energy (325-MHz) part of the initial pulse linac design [3] necessary for CW operation includes replacing buncher cavities and 16 room temperature cross-bar cavities with the SC spoke cavities.

In this paper we present the RF design of SSR0, SSR1 and SSR2 cavities. Also we will present the results of testing of the first two SSR1 prototype cavities. These cavities operate at 325 MHz with $\beta=0.21$.

The choice of β range for SSR0 and SSR2 in case of CW regime was conditioned by choice of the $\beta = 0.21$ for SSR1, which was successfully developed and tested. The Table 1 shows the break points between 3 types of SSR cavities.

Table 1: Break points between the sections in the SSR part of the CW linac

Section	Energy range MeV	β	Power/cavity, kW ($I_{av}=1$ mA)
SSR0	2.5-10	0.073-0.146	0.5
SSR1	10-32	0.146-0.261	1.3
SSR2	32-160	0.261-0.5	4.1

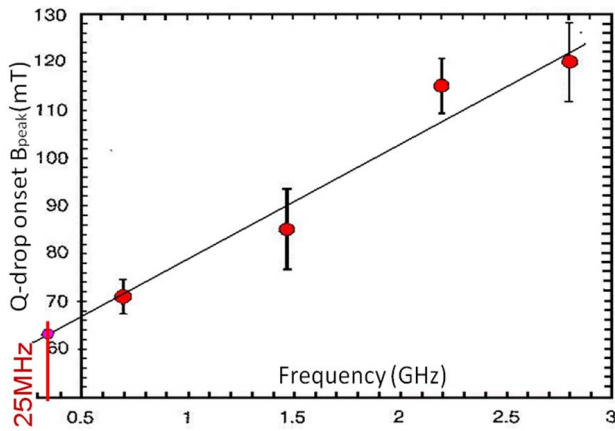

Figure 3: HF Q-slope onset vs. Frequency.

According to [4] the Q-drop onset field measured on cavities at different frequencies, between 0.7 and 2.82 GHz, seems to be consistent with the prediction, as shown in Figure 3. As is from the foregoing, we decided to limit the operating gradient of spoke cavities working at 325 MHz frequency by 60-mT of peak magnetic field.

SSR0

CW SSR0 cavities will be used for acceleration of the beam energy from 2.5 MeV to 10 MeV. The RF parameters of the SSR0 cavity for $\beta = 0.073-0.146$ was optimized. The results of optimization are shown in Table 2. Figure 4 shows the distribution of electric and magnetic fields in optimized cavity.

Table 2: SSR0 cavity parameters

Operating frequency	325 MHz
Optimal Beta, β_{opt}	0.114
Q_{load}	$6.5 \cdot 10^6$
E_{peak}/E_{acc}^{-1}	5.63
B_{peak}/E_{acc}^{-1}	6.92 mT/(MV/m)
G	50 Ω
R/Q	108 Ω
Cavity effective length, $D_{eff} = 2 \cdot \beta \lambda / 2$	105mm

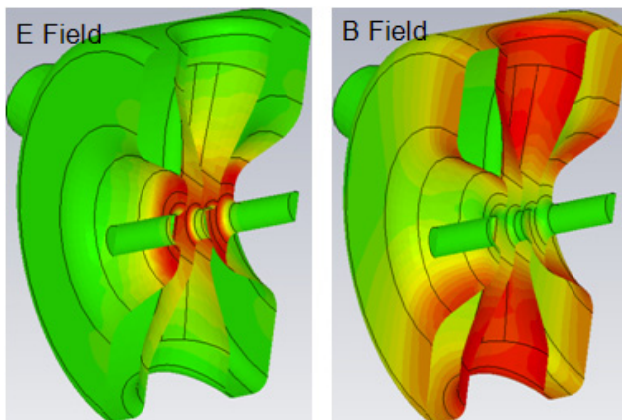

Figure 4: Distribution of electric (left) and magnetic (right) fields in optimized SSR0.

Figure 5 shows the sketch of layout of the SSR0 period. Due to longitudinal restrictions, SSR0 cavity RF design doesn't take the advantages of re-entrant shape similar to SSR1. The magnetic field enhancement factor is about 16% higher. The HOM analysis, power coupler and mechanical design of SSR0 is underway.

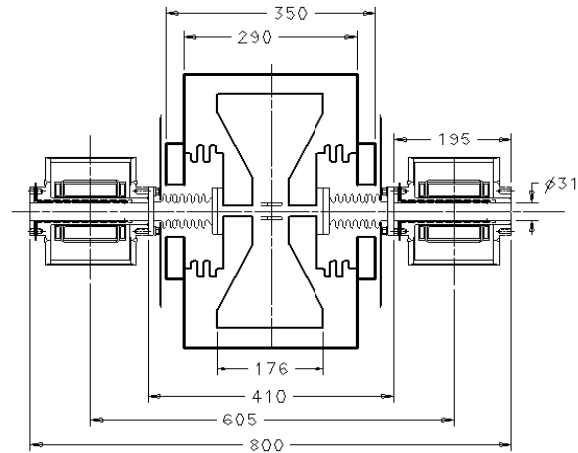

Figure 5: Layout of SSR0 period.

SSR1

The second family of spoke resonators SSR1 are the same as in the ICD-1 8 GeV linac and will accelerate the beam from 10 MeV to 32 MeV. Parameters of the cavities are shown in Table 3. Single spoke 325 MHz cavity SSR1 having $\beta_G = 0.21$ was designed and built for the HINS project. Results of the cavity tests are shown in Figure 6. The surface resistance dependence on the temperature is shown in Figure 7. One can see that the resistance at 4 K, and thus, quality factor, are more than 10 times higher than at 2 K. Conversion factor for cryogenics for 2 K is 700 W/W versus 200 W/W for 4 K, thus, the ratio is 3.5 (see also Table 4). It means that from efficiency point of view it is preferable to work at 2 K. In addition, at 2 K the level of microphonics is much smaller. However, average RF power requirements for CW operation are higher, and the coupler should be redesigned.

Table 3: SSR1 cavity parameters.

Operating frequency	325 MHz
Optimal Beta, β_{opt}	0.215
Q_{load}	$6.5 \cdot 10^6$
E_{peak}/E_{acc}^{-1}	3.84
B_{peak}/E_{acc}^{-1}	5.81 mT/(MV/m)
G	84 Ω
R/Q	242 Ω
Cavity effective length, $D_{eff} = 2 \cdot \beta \lambda / 2$	198.5mm

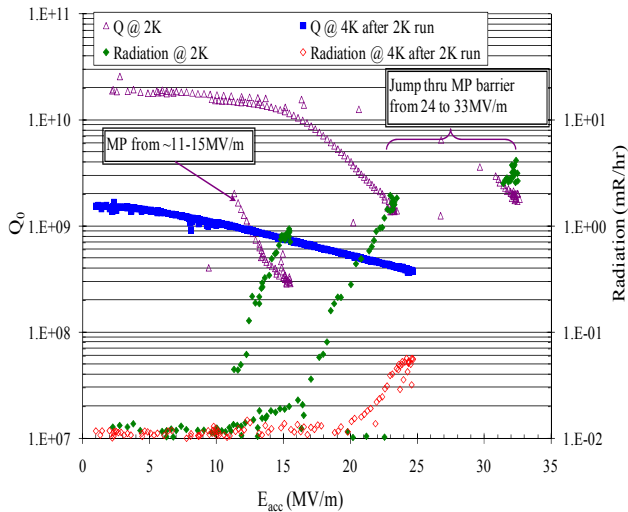

Figure 6: Q_0 vs. acceleration gradient E_{acc} from the first cold test of SSR1-02. In pink the quality factor versus the gradient is shown on different stages of the cavity conditioning at 2 K. In blue the quality vs the gradient is shown at 4 K after 2K run. Maximal $E_{acc} = 25$ MeV/m @4K; 33MeV/m@2K.

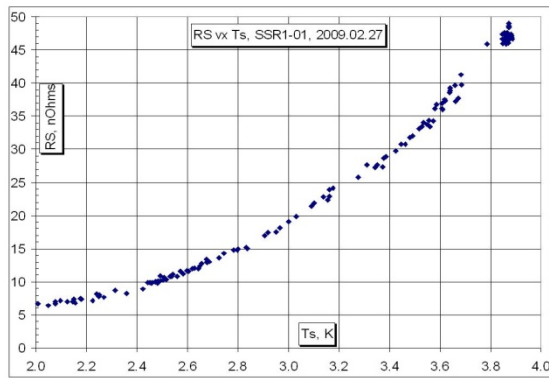

Figure 7: Temperature dependence of the surface resistance for SSR1 cavity.

SSR1 TUNER DESIGN

Each SSR1 cavity will be equipped with slow tuning and fast tuning devices to compensate for static and dynamic detuning.

The design for a fast/slow tuner has been developed and two prototypes have been tested in warm conditions as described in [5].

Each cavity will have two identical tuners (one per side) allowing the mechanical loads to be applied symmetrically and also providing redundancy.

The mechanism (visible in Figure 8) uses a stepper motor to control the position of the slow tuner arm via a harmonic drive (1:100 ratio). This arm pivots around bearings fixed to the helium vessel wall with a mechanical advantage of 5:1. The loads are transmitted to the beam pipe flange through two piezo actuators.

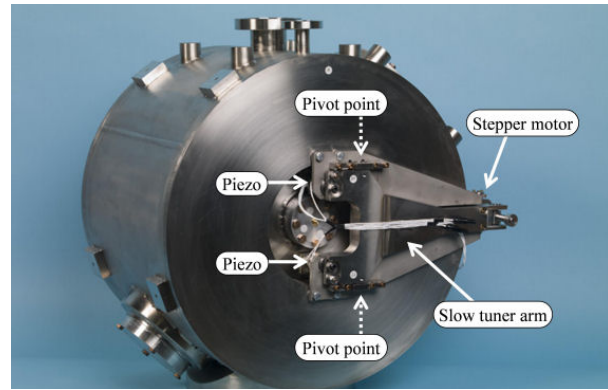

Figure 8 Jacketed SSR1-01 prototype with tuner mechanisms installed.

SSR2

The third family of spoke resonators SSR will be used for acceleration of the beam energy from 32 MeV to 160 MeV. The RF parameters of the SSR0 cavity for $\beta = 0.261-0.5$ was optimized for 2 different beam pipe diameter 30 and 40 mm. The results of optimization are shown in Table 4.

Table 4: SSR2 cavity parameters

Operating frequency	325 MHz	325 MHz
Beam pipe diameter	30mm	40mm
Optimal Beta, β_{opt}	0.414	0.419
Q_{load}	$1 \cdot 10^7$	$1 \cdot 10^7$
E_{peak}/E_{acc}^1	3.42	3.67
B_{peak}/E_{acc}^1	6.81	6.93
	mT/(MV/m)	
G	112 Ω	109
R/Q	304 Ω	292
Cavity effective length, $D_{eff} = 2 \cdot \beta \lambda / 2$	381.9mm	386.5

REFERENCES

- [1] ICD-1, Project X-doc-83, <http://projectx-docdb.fnal.gov/>
- [2] ICD-2, Project X-doc-230, <http://projectx-docdb.fnal.gov/>
- [3] P. Ostroumov, "Linac Beam Physics Design," Project X Workshop November 12-13, 2007.
- [4] H. Padamsee, "RF Superconductivity", Wiley-VCH Verlag GmbH&Co. KGaA, Vol. 2, P.173.
- [5] Y. Pischalnikov et al., "A tuner for a 325 MHz SRF spoke cavity", Proc. of the 14th international conference on RF-superconductivity, SRF 2009, Berlin, September 2009.