

RF TEST OF TWO-CELL PROTOTYPE FOR THE PEFP PROTON LINAC EXTENSION*

Han-Sung Kim[#], Hyeok-Jung Kwon, Yong-Sub Cho, KAERI, Daejeon, Korea
Sun An, PAL, Pohang, Korea.

Abstract

A superconducting RF cavity with a geometrical beta of 0.42 and a resonant frequency of 700 MHz has been under investigation for an extension program of Proton Engineering Frontier Project (PEFP) to accelerate the proton beam above 100 MeV. We developed and tested a two-cell prototype in order to confirm the fabrication procedure and check the RF and mechanical properties of such a low-beta elliptical cavity. The prototype has been fabricated with high RRR niobium sheets (RRR > 250). Double-ring structure was adopted to reduce the Lorentz force detuning effect. For the vertical test of the prototype cavity, a cryostat was designed and fabricated. Operating temperature is 4.2 K; therefore, pumping to reduce the pressure is not required. We applied 40 layers of super-insulation around the helium vessel in addition to the vacuum insulation between the helium vessel and outer chamber. The status of the prototype development and RF test results will be presented in this paper.

TWO-CELL SRF CAVITY DESIGN

Because the operating frequency of the RFQ and DTL of PEFP linac is 350 MHz, we chose the frequency of the prototype SRF cavity as 700 MHz. The major parameters of the two-cell elliptical niobium cavity for PEFP are like followings [1].

- Frequency: 700 MHz
- Operating mode: TM₀₁₀ pi mode
- Cavity type: Elliptical
- Geometrical beta: 0.42
- Number of cells: 2
- Accelerating gradient: 8 MV/m
- E_{peak}/E_{eacc}: 4.106
- B_{peak}/E_{eacc}: 8.28 mT/(MV/m)
- R/Q: 32.57 ohm
- E_{peak}: 32.85 MV/m (1.34 Kilp.)
- Geometrical factor: 124.58 ohm
- Cavity wall thickness: 4.3 mm
- Stiffening structure: Double ring
- Effective length: 0.18 m

The two-cell prototype cavity is composed of three parts; the center cells, a fundamental power coupler (FPC) beam tube and a field probe beam tube. We adopted a double-ring stiffening structure to reduce Lorentz detuning effect. The diameter of the cavity is 379.02 mm and the total length including the NbTi flanges is 528.78 mm. The drawing for the prototype is shown in Fig. 1

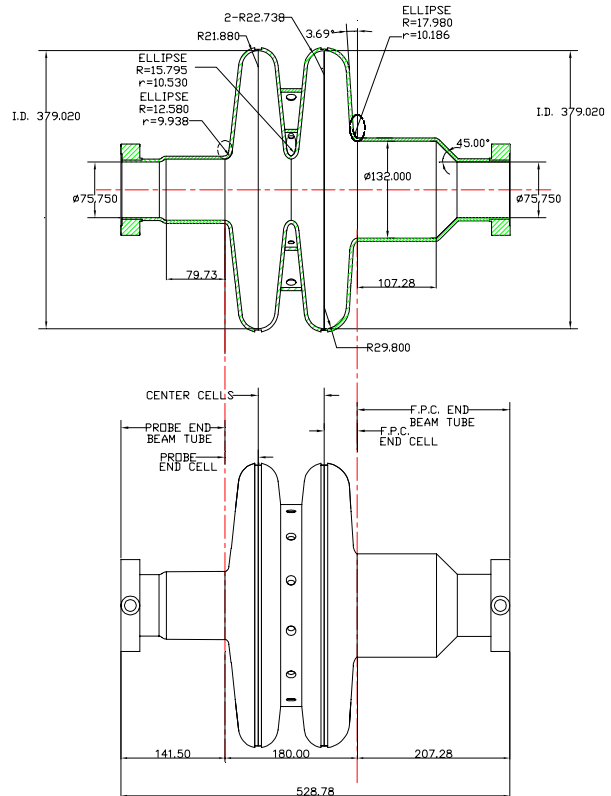

Figure 1: Drawing for the two-cell prototype cavity.

CAVITY FABRICATION

The cavity was fabricated through several processes such as machining, deep drawing and electron beam welding. Before the final equator welding, we etched the surface of each part by using an acidic solution, which consists of HF, HNO₃ and H₃PO₄ with a volume ratio of 1:1:2. The etching time was 4 minutes and 30 seconds, which is equivalent to removing the surface of 10 μ m. After etching, each part was cleaned with DI water. The cavity mounted on the electron beam welding machine with a fixing jig is shown in Fig. 2.

After the cavity fabrication, we measured the field profile by using a bead-pull method. The measured field flatness was about 1.8%. Considering the field flatness requirement of the PEFP low-beta cavity is 8.0%, the cavity needs no further field flatness tuning.

The inner surface of the fabricated cavity was treated through the chemical etching (CP) with removal of roughly 100 μ m. The etching solution was HF, HNO₃ and H₃PO₄ with a volume ratio of 1:1:2. After CP, the cavity inner surface was cleaned with high pressure rinsing (HPR) with ultra-pure water as shown in Fig. 3.

*Work supported by MEST of the Korean Government.

[#]kimhs@kaeri.re.kr

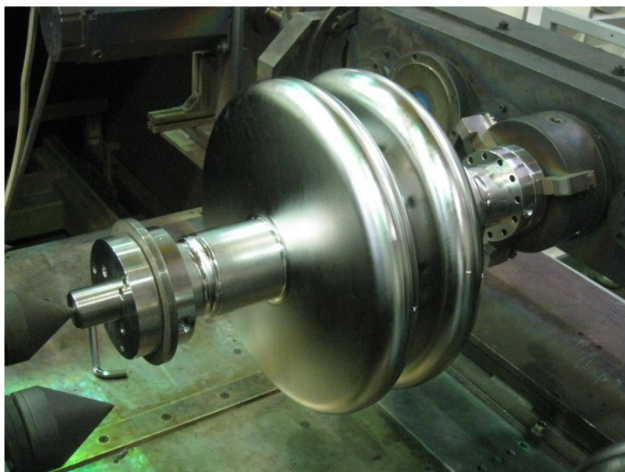

Figure 2: Prototype cavity mounted on the e-beam welder.

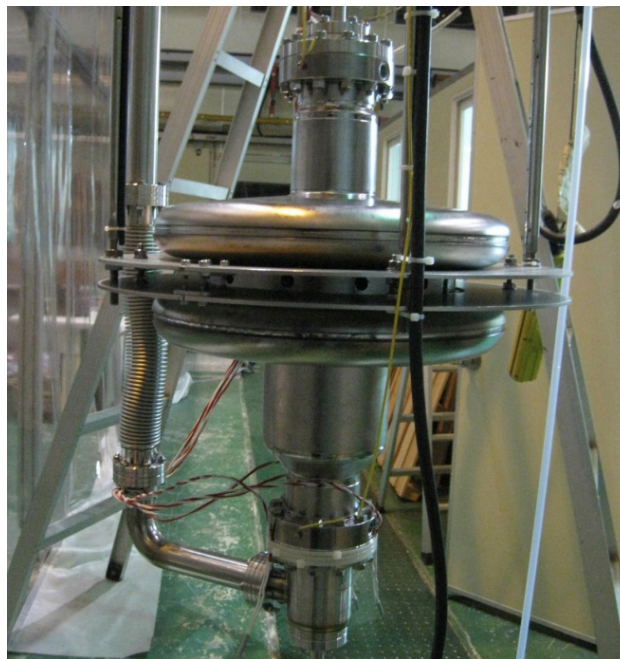

Figure 4: Prototype cavity installed in the insert.



Figure 3: High pressure rinsing of the cavity.

VERTICAL TEST SETUP

To test the prototype cavity at low temperature, we prepared the cryostat and the RF system [2]. The cryostat includes the vacuum jacket with 40 layers of the super-insulation and 10 layers of thermal reflectors at the upper part of the cryostat. It is equipped with liquid helium and liquid nitrogen level meters (LM-500, Cryomagnetics) and the temperature sensors (218E, Lake Shore). The static heat loss is estimated to be about 5.4 W. The height is about 2400 mm and the inner diameter is about 685 mm. Figure. 4 shows the prototype cavity installed in the insert of the cryostat and fig. 5 shows the fabricated cryostat.

The RF system is based on the phase locked loop (PLL) to main the cavity on resonance and to minimize the reflected RF power. The schematic diagram of the RF system is shown in Fig. 6. The vector signal generator (E4432B, Agilent) is used as VCO (voltage controlled oscillator) and phase comparator which generates voltage signal proportional to the phase difference between the forward and cavity RF power is used to drive the signal generator frequency modulation function. The trombone type phase shifter is used due to its large phase shift range (over 360 degrees at 700 MHz).

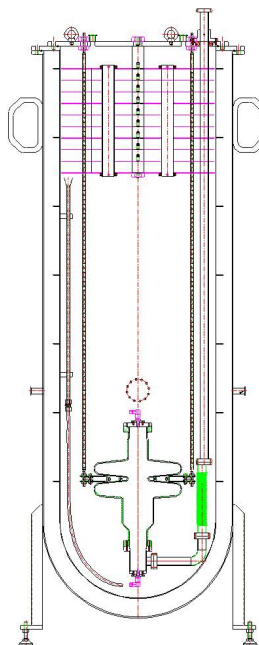

Figure 5: Drawing and photo of the cryostat.

TEST RESULTS

The cavity was pre-cooled by using liquid nitrogen. After drain of the liquid nitrogen, the liquid helium was transferred to the cryostat. Total liquid helium consumption was about 620 liters including cool-down process.

RF power of about 90 W is applied to the SRF cavity with pulsed mode. Pulse length was 50 ms. We measured the forward, reflected and transmitted RF power, respectively as shown in Figure 7. Yellow, red and blue traces represent the forward power, reflected power and

transmitted power, respectively. The cavity is equipped with two couplers; one is over-coupled and the other is under-coupled. The loaded Q and the coupling coefficient were obtained from the fitting of the reflected power waveform as shown in Fig. 8.

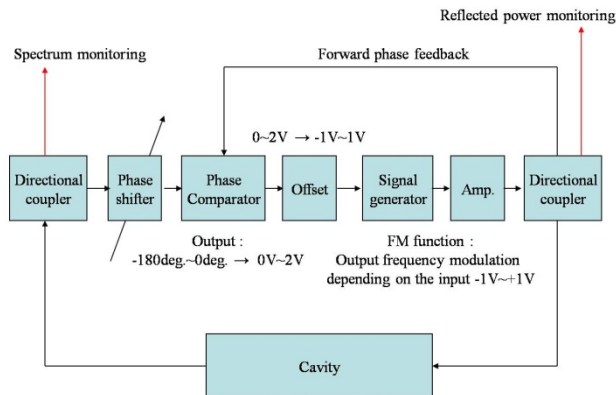

Figure 6: RF System setup for the vertical test.

From the measurement, the estimated unloaded Q was about $3.7E+7$. The accelerating gradient was estimated to be about 1.8 MV/m, which was limited by the RF amplifier.

The BCS resistance at 700 MHz, 4.2 K is about 155 n Ω [3]. If we assume that the residual resistance is about 250 n Ω including magnetic resistance, total surface resistance is about 405 n Ω , which results in unloaded Q of about $3.1E+8$. The reasons for such low measured Q are not fully explained yet and under investigation.

SUMMARY

A two-cell niobium prototype cavity has been designed, fabricated and tested under low temperature. During the prototyping, the design principles and fabrication procedures are well established. Test results shows that the accelerating gradient of about 1.8 MV/m can be obtained with RF power of 90 W. The measured unloaded Q was $3.7E+7$, which is lower than expected value. Based on the two-cell prototyping, a five-cell cavity was designed and under fabrication.

The authors wish to thank Younguk Sohn and his colleagues at Pohang Accelerator Laboratory for the chemical polishing and high pressure rinsing.

REFERENCES

- [1] Sun An, Y. S. Cho and B. H. Choi, "PEFP Low-beta SRF Cavity Design", PAC'07, Albuquerque, 2007.
- [2] Han-Sung Kim, Hyeok-Jung Kwon, Yong-Sub Cho and Sun An, "Prototyping and Vertical Test for PEPF Low-beta Elliptical Cavity", SRF2009, Berlin, 2009.
- [3] Hansan Padamsee, Jens Knobloch and Tom Hays, "RF Superconductivity for Accelerators" Wiley-VCH Verlag GmbH & Co. KGaA, 2008.

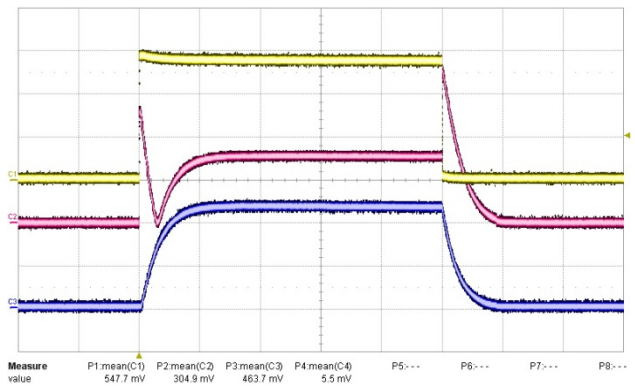

Figure 7(a). Over-coupled case

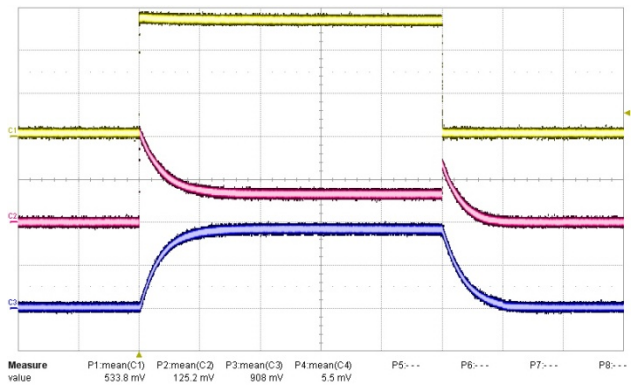

Figure 7(b). Under-coupled case

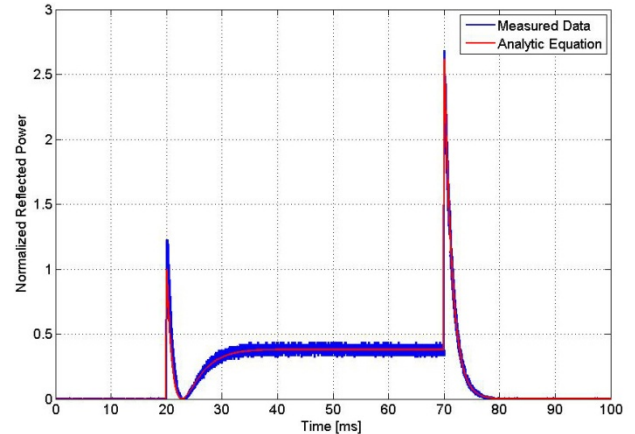

Figure 8(a). Over-coupled case (beta: 3.65, Q_l : $6.2E+6$)

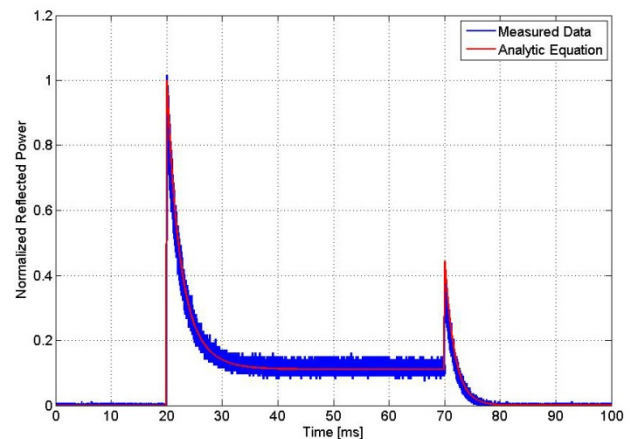

Figure 8(b). Under-coupled case (beta: 0.49, Q_l : $7.0E+6$)