

DESIGN OF TPS CROTCH ABSORBER

I. C. Sheng, Y. T. Chung, C. K. Kuan, G. Y. Hsiung, J. R. Chen, C. Y. Yang, NSRRC, HsinChu 30076, Taiwan

Abstract

Taiwan Photon Source (TPS) is a third generation synchrotron accelerator with 3 GeV designed energy and 500 mA beam current. The role of crotch absorber is used to protect downstream UHV vacuum chamber. It is the only heat mask component to absorb large amount of synchrotron radiation (bending magnet) in the storage ring. Crotch absorber is installed from transverse direction of the bending chamber to intercept the power. Two bent OFHC copper tubes are vacuum brazed on the copper mask. A 30 degree V groove is machined to face bending magnet fan. The reason is not only to dissipate the heat but also to limit back scattering to the rest of chambers. Top and bottom of the absorber are bolted with beryllium copper springs; they will provide extra support for the absorber after it is installed in the Aluminium chamber. Final prototype of the crotch absorber with thermal analysis, design and machined parts are also presented in this paper.

INTRODUCTIONS

Taiwan Photon Source (TPS) at the National Synchrotron Radiation Research Center (NSRRC) is constructing a third-generation accelerator. The accelerator is designed for use with high heat-flux hard X-rays, which part of the radiation should be shadowed to protect high ultra vacuum (UHV) components downstream ends. TPS storage ring has total of 48 bending chambers, that is, each dipole magnet generates 9kW at 3GeV beam energy, 500 mA designed beam current and 8.4 m bend radius. The bending magnet power density results in area power density 261 w/mrad^2 , linear angular power density 68 w/mrad and with beam sizes 0.34 mrad . There are total of 3 types of bending chambers in TPS, that is, B1 (for ID), B2 (for BM) and B3 (typically for IR). Crotch absorber for each bending chambers has similar design except different length and aperture to protect transverse area of the downstream bending chambers. Table 1 itemizes the parameters of each crotch absorbers:

Table 1: Parameter of the crotch absorber protection zone

Crotch absorber type	B1	B2	B3
distance from source (m)	2.3	2.7	1.9
Total length (mm)	531	548	388
Intercepted power (kW)	7.5	8.2	6.8
Vertical aperture (mm)	20	14	14
Horizontal aperture (mm)	60.5	60.4	60.4

Spring support	Yes	Yes	No
Total weight (kg)	10	11	9
No. of assembly required	24	18	6

For instance, as to B1 absorber, its maximum peak power density at these distances for crotch absorber is about 25 w/mm^2 whereas the corresponding linear power density is 15 w/mm .

THE DESIGN

Since the top and the bottom of the storage chamber downstream have limited space and are the only place for pumping, and there are around 500 mm transverse length to be shadowed, crotch absorber can only be designed and installed from storage ring chamber outbound sideways.

Both top and bottom halves of TPS Aluminium storage ring chambers are precision machined and then welded into one chamber assembly, the total height of the welded chamber is around 100 mm, with minimum 10 mm thickness on both sides, the cross section profile of the crotch absorber is limited to 80 mm diameter. OFHC copper has been used widely in accelerator engineering, therefore we also adopt it as a heat sink to take the heat away. Machined copper main body is vacuum brazed onto a 6" SST flange. Heat load striking on the OFHC copper is then dissipated by 3/8" OFHC copper tubes running with DI water inside. One bent tube is brazed on the top and another is on the bottom of the copper body. As shown in Figure 1.

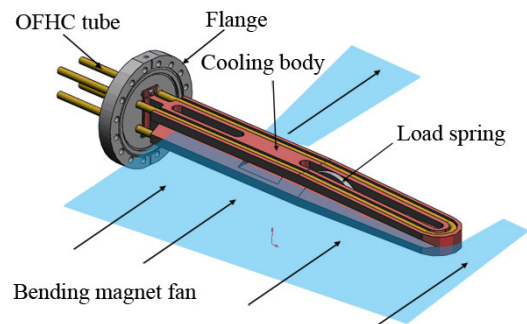

Figure 1: TPS crotch absorber design

With two bent tubes bending around on top and bottom, instead of making copper main body and flange vacuum to air brazing joint, we only make four circular water tubes as air-to-vacuum brazed joints. The benefits with this design are 1.) Minimize air-to-vacuum joints to enhance brazing quality. 2.) Round geometry has much better scenario for molten brazing alloy to flow which enhances capillarity action to take place, this will result

in better brazing results. The end surface of the copper body braced onto the inner flange surface simply for support and connection purposes.

OFHC copper block has circular channels both on top and bottom so that water cooling tubes are first placed by 50Au/50Cu 0.002" thick brazing foils on the bottom circular channels, later a fixture is developed by local company to compress annealed copper tubes to the channels, more than 50% of circumference of the tube is able to fully brazed on the copper main body. A brazed sample in Figure 2 illustrates that contact surface brazing result between copper tubing and the copper body is over 50%.

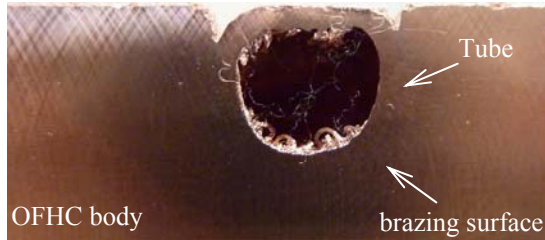

Figure 2: Sample of water tube brazed on copper channel.

As to B1 crotch absorber, a 60.5 mm (*w*) × 20mm (*h*) aperture is arranged for ID beam to pass through, whereas B2 and B3 are 60.4 mm (*w*) × 14 mm (*h*) and only for bending magnet fan. Note that the reason B1 absorber has wider vertical opening is because TPS will have elliptical polarized undulator (EPU) which horizontal deflection parameter K_x will be at about 3. The distance from ID to B1 crotch absorber aperture is around 10 m~12 m, therefore vertical EPU beam size will be 12.2 mm maximum. By adding up ±2 mm offset, ±0.2 mrad angular miss-steering and giving ±1 mm miss-alignment, we leave approximately 1 mm each side as our safety margin to avoid crotch absorber being heated by undulator.

The heating surface facing bending magnet fan along transverse direction has a 60° V-shaped groove. Several reasons for this groove:

1. To minimize back scattering: If bending magnet is striking on the absorber head-on, scattering light will bounce back directly to all over the chamber, this will lead to higher vacuum pressure in the upstream of storage chamber.
2. To reduce peak temperature: 60° V-shaped groove gives synchrotron radiation a corresponding incident angle, which reduces peak power density by half.
3. To enhance heat dissipation: Since the cooling tubes are both on top and bottom, the groove introduces more heat dissipation areas to the tubes.

Two screws are bolted onto the copper block and the flange before brazing. They are used to increase the

perpendicularity between the datum plane (flange mounting face) and the copper body, and to secure these two parts. Those screws have through holes at the centre to prevent them from virtual leak.

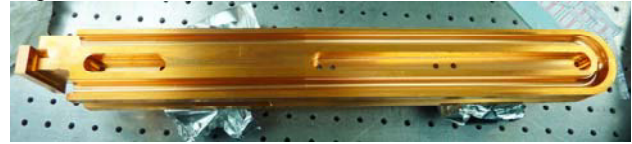

Figure 3: Machined piece of B1 crotch absorber OFHC cooling body.

THE ANALYSIS

A thermal analysis is performed via SolidWorks finite element simulation. Peak power density of 25 w/mm² with beam height of 0.77 mm. 1 w/(cm² °K) film coefficient is assumed for the cooling tube. As shown in Figure 4, maximum temperature rise is 136 °C.

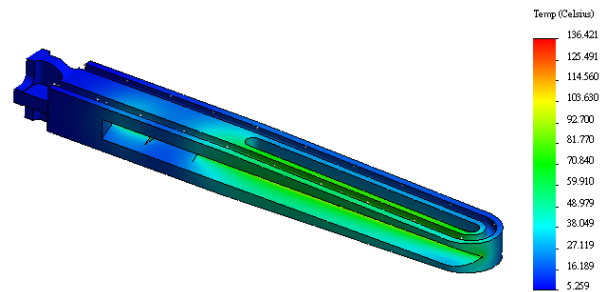

Figure 4: 3D temperature contours of TPS B1 crotch absorber subjected to bending magnet power.

Successive thermal-induced finite element stress analysis is also presented in Figure 5. The maximum effective thermal stress along the heating zone is around 120 MPa. According to several other absorber researches, for instance, [1][2], the thermal stress for B1 is passively safe.

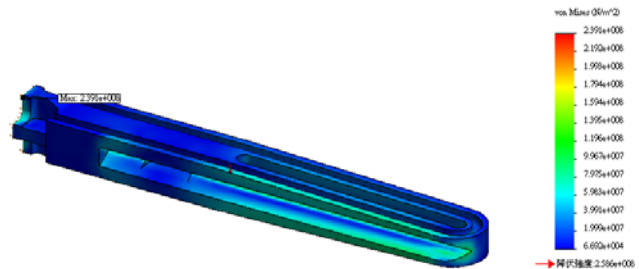

Figure 5: 3D thermal stress contours of TPS B1 crotch absorber.

THE FABRICATION

Most of the machining effort in crotch absorbers is in the cooling block body and the flange, as are shown in Figure 3 and Figure 6. OFHC copper raw material is provided by domestic company in Taiwan and machining is done by local company as well. To minimize out-

gassing and vacuum cleaning effort, only alcohol is used as the only lubricant during machining.

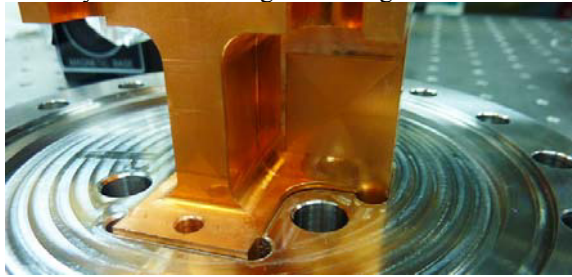

Figure 6: Machining of crotch absorber flange marries with copper block

After flange and cooling body are fabricated, two OFHC tubes are bent and fit to the U-shaped water channel pathways. The fixture to bend the tubes ensures no notches will be introduced during pressing. With 3/8" tubes the bend radius we can achieve is 20mm, while the circular cross section of the tubes is retained.

During brazing, a brazing fixture (as shown in Figure 7) is also developed for crotch absorber to securely sit inside the vacuum furnace. Since both top and bottom have two long water tubes to be brazed, we place crotch absorber brazing assembly in the furnace such a way that 30° V grooved side is face downward. The reason being is the V grooved face will receive bending magnet power; therefore it requires better brazing contact between water tube and copper body on that side. Facing downward will result in molten brazing alloy tending to flow toward to the that direction. Brazing result on the other side (the opposite side of V grooved surface) is not that critical since it won't see bending magnet fan. To reduce total weight, we mill machined several elliptical grooves on both top and bottom surfaces, in addition, right beyond opening aperture along the longitudinal direction the absorber is tapered down to 26mm height at the end. This reduces total B1 crotch absorber assembly from 12kg to 9kg.

Two Beryllium-Copper springs are bolted on top and bottom copper body, they are designed to share partial self weight. Figure 8 shows cross sectional view of installed B1 crotch absorber and chamber. The location of the load springs is chosen right after the bump opening area. From structural point of view it may not be an optimized place to share the self weight load (Considering the entire crotch absorber acts as a cantilever beam with extra supports). However, positioning load springs near to the electron fish-eye shaped chamber may somewhat interfere electron trajectory.

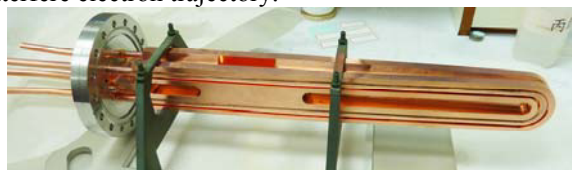

Figure 7: Final brazed assembly of B1 crotch absorber.

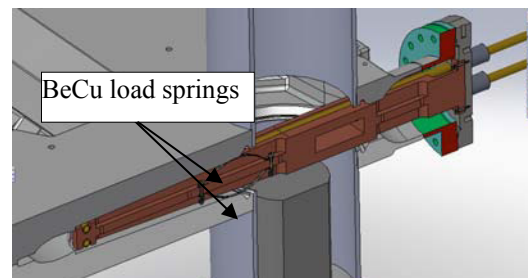

Figure 8: Section view of installed B1 chamber and crotch absorber.

The springs are only installed in B1 and B2 crotch absorbers but not B3. B3 absorber has shorter length (388 mm) and no space for the spring therefore it is omitted.

Only B1 crotch absorber has brazed and fully assembled. Brazing B2 and B3 are in the process. The leak check of brazed B1 absorber reaches 10^{-10} mbar-L/sec. whereas the brazed water channels can sustain over 120 psi pressure.

After the brazing, we have also checked the perpendicularity, and found that even prior to the brazing we have carefully setup the assembly, the accumulated parallelism tolerance between flange bolting surface and 6 cm × 3 cm brazing mating surface is found to be 0.06 mm, this will introduce 1mrad tilting. As to B1 crotch absorber, its total length is 500 mm (in Table 1). Thus after brazing, the maximum yaw or pitch of the copper cooling body w.r.t. flange surface caused by this machining tolerance will be 0.5 mm. The measurement shows that there is less than 0.1 mm pitch whereas yaw is more than 2 mm. Further pre-brazing preparation has to be done to meet better perpendicularity.

CONCLUSIONS

After thermal and thermo-mechanical analysis have proven both temperature and stresses are safe, some of three types TPS crotch absorber parts have been machined and delivered, stainless steel flanges and OFHC copper cooling body, copper water tubes are fabricated and brazed by domestic companies. Overall, B1 crotch absorber is the only assembly which has been brazed and passed vacuum leak as well as water pressure test. The measurement results reveal that there are still some room to improve the precision of final brazing assembly.

REFERENCES

- [1] L. Zhang, J. C. Biasci and B. Plan, "ESRF Thermal Absorbers: Temperature, Stress and Material Criteria", MEDSI02, September 5-6,2002.
- [2] I. C. Sheng, S. Sharma, R. Rotela and J. Howell, "Thermomechanical analysis of a compact-design high heat load crotch absorber", Proc. of the 1995 Particle Accelerator Conference, Dallas, Texas (1996) 816-818.