

LIBERA LLRF – DEVELOPMENT AND TESTS

G. Jug, A. Kosicek, Instrumentation Technologies, Solkan, Slovenia

Abstract

In this article we are presenting tests and development of digital low level RF control system Libera LLRF. Libera LLRF is a digital system small in size but powerful in terms of performance as tests revealed. Size of unit matches industrial standards and is in 19" 2U sustainable metal box that fits into racks. Development of the Libera LLRF reflects needs of accelerator's and their operators. With its capabilities it is a system that is able to control RF at 4th generation light sources. Concept of the Libera LLRF system also enables implementation of operator's own solutions in controlling RF. During preparations for testing Libera LLRF's features proved to be useful since little time was needed to install and operate the system. In some cases its features and capability enabled operators to identify and quickly resolve problems that were accelerator's components related.

DEVELOPMENT OF LIBERA LLRF

Libera LLRF is a digital low level RF stabilization system. Motivation for development was mainly to have the digital system that is both hardware and software configurable.

Hardware configurable system was achieved by using ATCA standards that are based also on μ TCA.

Software configurable system was achieved by using FPGA large enough so also user has space to implement their solution for control algorithms in it with software that handles operation and input/output of data.

Libera LLRF with different functionalities was tested at different machines:

- EMMA - proof of concept for Non Scalling Fixed Field Alternating Gradient accelerator
- FLASH – test setup for XFEL
- FERMI@ELETTRA – FEL

BRIEF DESCRIPTION OF LIBERA LLRF

Libera LLRF is a digital, configurable system that maintains stable RF field in the cavity at set amplitude and phase. Stability depends on control algorithm employed.

With its functionality, Libera LLRF also characterizes RF system, analyse optimal parameters for control algorithm and suggests them to the operator. Operator can either use suggested parameters or can apply different one.

After closing the loop, control system is employed to maintain stable field in the cavity through operation time of the system.

In cases of extraordinary events, interlock system is used to stop RF.

Connection to the network helps operators to remotely access Libera LLRF unit to monitor and set parameters.

TEST RESULTS

EMMA

EMMA (Electron Machine for Many Applications) in Daresbury, UK was built as a proof of concept for non scaling fixed field alternating gradient accelerator (NS FFAG). Frequency of RF field depends on revolution frequency. Accelerated particles that have different revolution frequencies, need for acceleration different RF. Also particles at different energies are traveling in different orbits. To have efficient acceleration of them, the RF has to change slightly.



Figure 1: EMMA NS FFAG test setup, Libera LLRF on the table - bottom left corner of the picture.

Libera LLRF algorithms for EMMA are configured to operate in such regime.

After setting up two cavity system at Daresbury laboratory and verifying everything is in order, measurements of stability were done.

Pulses were 1.6 ms long with repetition rate of 10 Hz.

Power was gradually raised up to 10 kW and vector sum of the field in two cavities summed up to 300 kV.

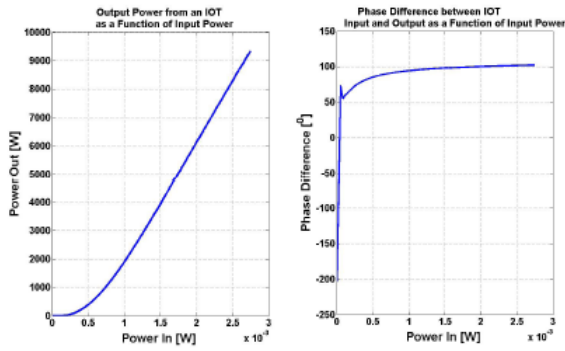

Figure 2: Measured nonlinear effects of IOT with Libera LLRF.

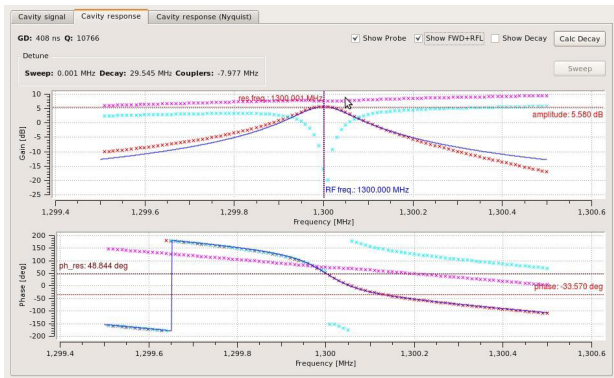

Figure 3: RF system analysis made on the first cavity at EMMA.

FLASH

FLASH is a free electron laser (FEL) at Desy, Germany. It is also a test facility for future XFEL. Operational RF of FLASH is in majority at 1.3 GHz. We have controlled section ACC456. Three Libera LLRF units were configured in order to control the 24 acceleration cavities, 72 RF signals (24 probe signals, 24 forward and 24 reflected RF signals) were acquired and processed in real time.

After connecting Libera LLRF system to FLASH RF system, approx. 30 minutes were needed to identify and calibrate the readouts of the signals.

The RF cavities were fully characterized by means of the built in RF system diagnostics functions and the Nyquist stability analysis algorithm was used for the automatic loop parameters optimization.

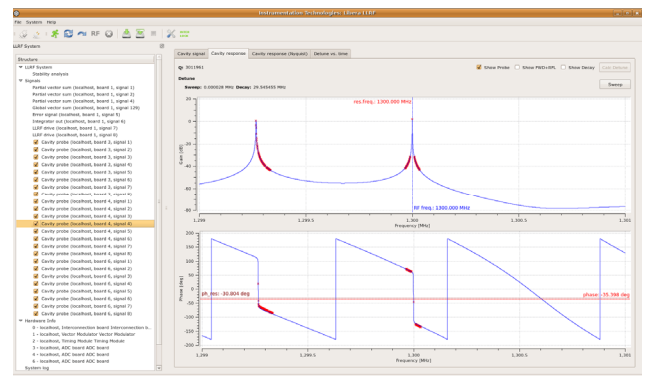

Figure 5: Characterization of RF system in GUI as part of Libera LLRF RF system diagnostics functionality.

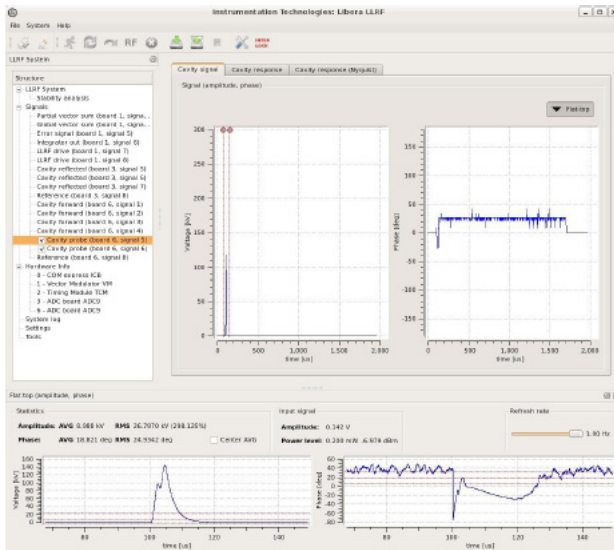

Figure 4: Interlock triggered by Libera LLRF.

Response of interlock was also tested by triggering it deliberately. Reaction time of Libera LLRF was in range of few μ s.

In this setup, measured stability was 0.005 % in amplitude and 0.008 $^{\circ}$ in phase over 1 MHz bandwidth.

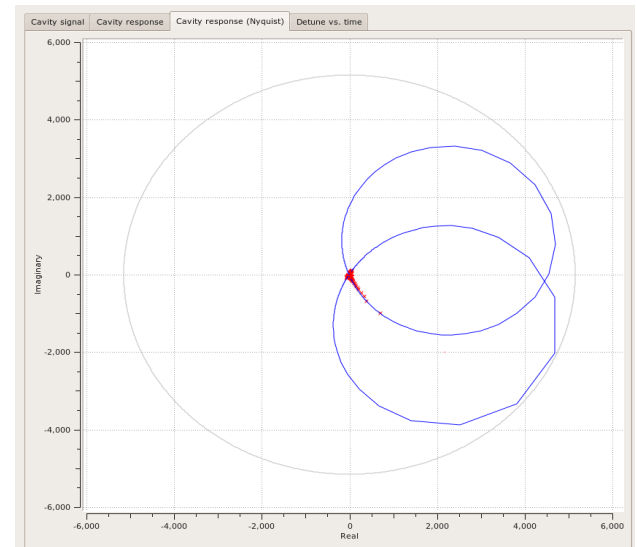

Figure 6: Nyquist stability analysis of the control system.

Afterwards, the loop was closed and the proportional gain was raised. The effect of the passband modes from the beam was observed at higher gains and mitigated by means of the digital phase shifters fine adjustment. The gradient in the cavities was increased up to 30 MV/m (ACC6).

The cavities were loaded by the beam and the beam induced transients were characterized. The amplitude and phase of the ACC456 vector sum were adjusted by Libera LLRF for optimal transmission of the beam, and a continuous SASE radiation of 10 uJ/pulse was established.

The RMS amplitude stability achieved was 0.009 % and a phase RMS stability of 0.0095 °.

FERMI@ELETTA

Fermi@Elettra is a FEL construction at Sinchrotrone Trieste, Italy. At time of testing its RF was 3 GHz. Pulse length was 2 μs and repetition rate 10 Hz.

Tests were performed on K2 section. One klystron drove 2 normal conducting cavities.

Goal of testing was to measure amplitude, phase stability of the pulses and robustness of control algorithm to induced noise into control loop. Measuring setup is shown in figure 7.

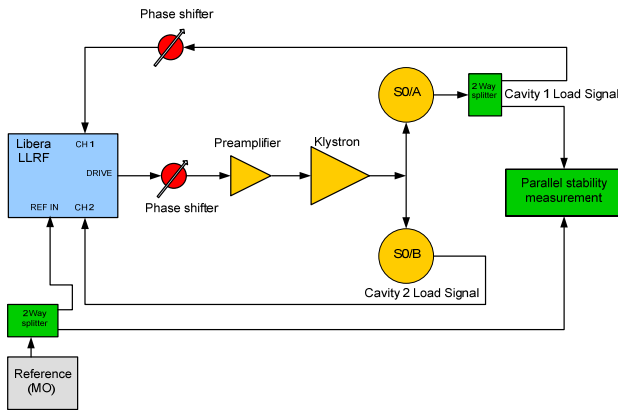

Figure 7: Measurement set-up.

Working point of the klystron and preamplifier was set to be in linear region of characteristics. In selected working point the RF output power of klystron was 33 MW.

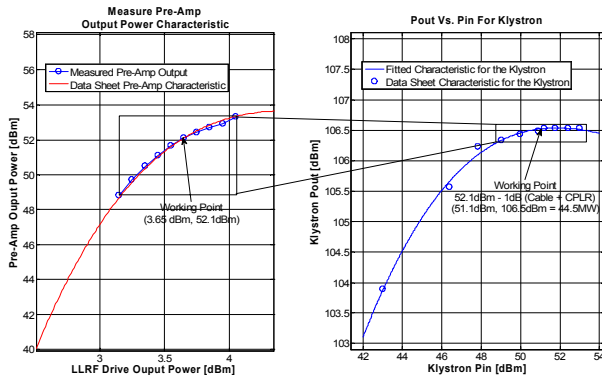

Figure 8: Pre-amp and klystron output power dependence measurements.

We closed the control loop around one cavity (S0/A) in the other we only monitored RF field. For the introduction of noise into control loop's forward and reverse path we used voltage controlled phase shifters as it is shown in the figure 7.

Before phase shifters were connected into the setup, their frequency response was measured with SSA.

To double check the stability measurements, parallel measurement of phase stability was set.

After setup installation the Libera LLRF was calibrated.

The next step was the optimization of parameters for controller algorithms. Stability of the pulses was measured. In closed loop, the amplitude stability of 0.027 % RMS in amplitude and 0.033 ° RMS in phase.

CONCLUSION

Tests at EMMA and FLASH were at 1.3 GHz RF while at Fermi@Elettra RF was at 3 GHz. All three machines operate in pulsed mode.

Control algorithms employed differ in those three cases. At Fermi@Elettra testing, it was pulse-by-pulse feedback, at FLASH and EMMA there were intrapulse feedback control algorithms employed.

In all cases tests confirmed that we are on the right path with development of the system and that customization to different accelerators is relatively easy. Besides the system very flexible in terms of hardware and software.

REFERENCES

- [1] B. Baricevic et al., "Evaluation of the analog and digital receiver section in the Libera LLRF system", PAC09, Vancouver, 2009.
- [2] B. Baricevic et al., "Libera LLRF Tests at FLASH (DESY)", <http://www.i-tech.si/support.php?meni1=7>