

## A 12 GHZ 50MW KLYSTRON FOR SUPPORT OF ACCELERATOR RESEARCH\*

Daryl Sprehn, Andrew Haase, Aaron Jensen, Erik Nyls Jongewaard, Christopher Dennis Nantista, Sami Tantawi, Arnold Vlieks, SLAC National Accelerator Lab., Menlo Park, CA 94020, U.S.A.

### Abstract

A 12 GHz 50MW X-band klystron is under development at the SLAC National Accelerator Laboratory Klystron Department. The klystron will be fabricated to support programs currently underway at three European Labs; CERN, PSI, and INFN Trieste. The choice of frequency selection was due to the CLIC RF frequency changing from 30 GHz to the European X-band frequency of 11.99 GHz in 2008. Since the Klystron Department currently builds 50MW klystrons at 11.424 GHz known collectively as the XL4 klystrons, it was deemed cost-effective to utilize many XL4 components by leaving the gun, electron beam transport, solenoid magnet and collector unchanged. To realize the rf parameters required, the rf cavities and rf output hardware were necessarily altered. Some improvements to the rf design have been made to reduce operating gradients and increase reliability. Changes in the multi-cell output structure, waveguide components, and the window will be discussed along with testing of the devices. Five klystrons known as XL5 klystrons are scheduled for production over the next two years.

### INTRODUCTION

The 50MW XL4 klystron, operating at 11.424GHz, has been an essential workhorse in X-band research over the last 13 years [1]. These klystrons nominally operate at ~420kV, 1.5us at 60Hz and use a 4700G magnetic confinement field. To date, 15 of these klystrons have been constructed and their power utilized for evaluating performance of passive X-band components, accelerator and rf breakdown research, beam-linearization in LCLS and for an RF photoinjector gun. The design of these klystrons is fairly traditional except for the more complicated issues dealing with extraction and delivery of the rf power and, perhaps, the distribution of the penultimate cavity into three separate cavities in order to lower gradients. Though the XL4 design is mature there is always room for improvement hence recent work in practical high-power X-band klystrons at nearby frequencies, as discussed below, has renewed interest in applying improvements to the XL4 design.

Due to high-power research at the European X-band frequency near 11.99 GHz and a lack of a high-power rf source, a need was identified to create a new klystron similar to the XL4 klystron in performance. Three laboratories, at CERN, PSI, and INFN Trieste, had requirements that were close in frequency and rf duty that a common design was thought feasible. After a preliminary design investigation that heavily emphasized

developmental cost-reduction, it was concluded that much of the XL4 design could be used for a new klystron which is now known as the XL5 design.

### KLYSTRON DESIGN CONSIDERATIONS

To reduce development cost and speed development, an initial investigation was made to determine whether the XL4 beam formation, transport, focusing and collection might all be used without too much loss of gain-bandwidth and peak-power performance. Since the XL5 frequency is 5% higher and the drift tube sized for the lower XL4 frequency, the coupling between the beam and cavities suffers slightly and this reduces the available gain-bandwidth and the peak power at a given beam voltage. The larger relative drift tube also raises issues concerning a change in propagating modes but such issues existed in previous XP klystron work [2] with no obvious detrimental effects. To increase part commonality it was determined that maintaining the existing cavity spacing would also be of benefit as another cost-cutting measure. It is also known that the XL4 operates at 50MW at a beam voltage lower than design and so an optimization of the XL5 at a lower beam voltage could potentially offset some of the previous concerns. With the above issues in mind, initial 1.5D beam-interaction simulations indicated that performance (as measured by gain, bandwidth, gradients and output power) looked promising enough to begin a detailed design in earnest.

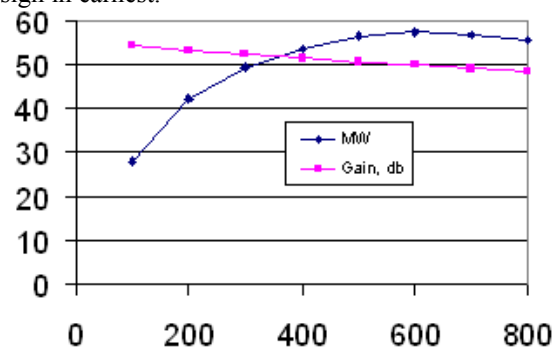

Figure 1: A 1.5D simulation of output power and gain vs. rf drive at  $V_b=400\text{kV}$ .

### KLYSTRON DESIGN

The XL5 klystron design target was set for 50MW at a beam voltage below 450kV, an efficiency of 40%, a gain of 50dB and a 50MHz -3dB bandwidth. By setting a design point at 400kV and the fact that the XL5 frequency is higher than the XL4, the XL5 klystron looks longer by 6% and this helps offset the loss of gain-bandwidth due to

\*Work supported by the Department of Energy under contract No. DE-AC02-76SD00515 and by WFO agreements with CERN, INFN Trieste and PSI.

the reduced coupling (coupling coefficients drop by ~5%) when compared to the XL4. However this does not make up for all of the effects especially at the output structure where gradients are also of prime importance and so it is expected that the XL5 will require slightly more beam voltage than the XL4 for a given power output.

Gradient reduction in the output structure was accomplished by three methods. The first method was to add a very large radius at the output cell iris; this same method will be adopted in future XL4 klystrons. The second method was to optimize for a lower beam voltage which effectively peaks the efficiency where it is required and helps to reduce gradients in the first three cells as well as those in the klystron penultimate cavities. The third method was a re-optimization of the output structure tuning to equalize the gradients.

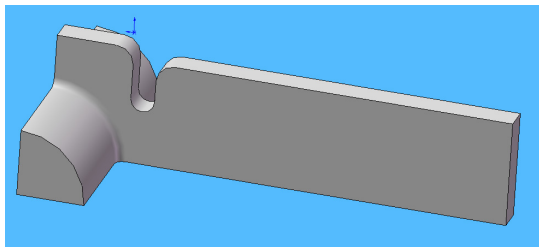

Figure 2: XL5 Output coupling cell and iris (¼ geometry).

A few hundred MAGIC simulations were performed to optimize the output structure in terms of power output, gradients, bandwidth, gain and spent beam energy. Compromises are always made with so many variables to choose from but the final result yielded similar performance to the XL4 with a flatter field and gradient profile. In Table 1 are comparisons at 52.5MW rf between XL4 and XL5 output structure voltages and spent energies. Figure 3 shows excellent agreement between the MAGIC simulations [3] of the final design compared to eventual test data.

Table 1: Voltages and energies for XL4 and XL5 using MAGIC with similar simulation parameters and methods.

Tube	kV1	kV2	kV3	kV4	gamma
XL4	44.3	98.6	91.0	79.5	5.3%
XL5	71.0	66.4	72.0	77.5	6.5%

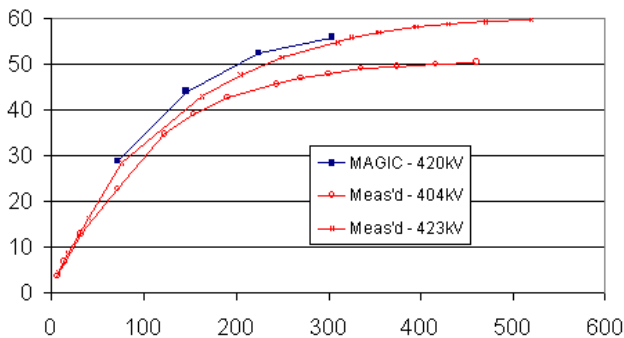

Figure 3: XL5 MW output vs. W input for simulation at 420kV and XL5-1 test data at 404kV and 423kV.

## OUTPUT WAVEGUIDE COMPONENTS

The rf from the output structure passes through two waveguides (see Fig. 2), each which connect to an impedance transformer and bends and then combine as shown in Fig. 4. Since the existing XL4 rf combiner was sensitive to dimensional tolerances, especially in regards to the inductive tuning element, and the combiner required design at a new frequency, the opportunity arose to incorporate a more modern tuning method by using rounded capacitive wall irises. Simulations of the bends, tuners and waveguide dimensions showed the reflection <-40dB across the required 50MHz bandwidth for all variations of mechanical tolerances.

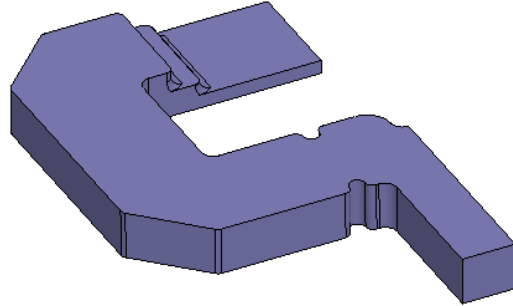

Figure 4: XL5 Output combiner, half symmetry.

To keep costs low and maintain the XL4 gradients, existing [4] TE01 window ceramics and input waveguide components were used. Since one more mode can now propagate than at the XL4 frequency, an extra intermediate step was added to properly convert the scattered modes from the input waveguide to the window surface. The VSWR response and window gradients at 75MW power across 100MHz are shown in Fig. 5.

XL5 output window  
Design 09Mar11\_6A

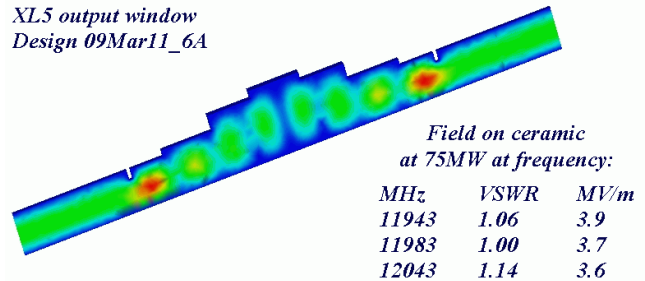

Figure 5: Fields in XL5 Output window, axial symmetry.

The mode converter also required design work at the new frequency. A converter which first converts to oversized rectangular guide and then quickly morphs into the circular waveguide was deemed optimum but would not fit within the limitations of the bake-out station thus we opted for a new version of the XL4 “wrap-around” mode converter [4]. The new mode converter has a VSWR <1.1 across the 50MHz bandwidth.

## OSCILLATION MITIGATION

Examining the 4 axially symmetric modes in the output structure with no loading by integrating along the axis for various beam velocities indicates that the pi-mode at 12.839GHz will oscillate. In this case, we also ran

MAGIC simulations by unloading the output structure to verify the effect. Such behaviour is typical in multi-cell structures and has been dealt with successfully on XL and XP klystron designs. Our method of providing loss is to rely on the out-of-band reflection from the mode converter and window assembly by inserting a side-coupled loss cavity at the correct location.

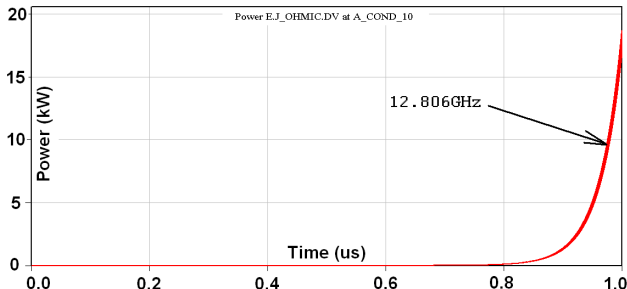

Figure 6: XL5 MAGIC simulation of unloaded output structure shows oscillation after 600ns at 12.806GHz.

An analytical analysis indicated that a Q of  $\sim 1800$  for this mode was at the edge of stability and MAGIC simulations showed that a Q of 1200 would damp a pre-excited mode. It is believed that our loss cavity will drop the Q to  $< 200$  and so the mode should be stable.

## TESTING

The first 11.99 GHz klystron was tested between February and April 2010. Due to multipactor and breakdown in the external output rf coupler, splitter and loads, there were several reconfigurations of these components and successive bakeouts. Finally, two stainless steel waveguides were used to provide 3dB of loss before these external components and the problems were alleviated, though not removed altogether. However, testing was still completed in a satisfactory manner and the klystron behaved as predicted; similar to the XL4 but requiring an extra  $\sim 20$ kV of beam voltage and hence a slight reduction in efficiency. Operational data of the saturated output power for the XL4 (upper curve) and XL5 (lower curve) for various beam voltages is shown in Fig. 7.

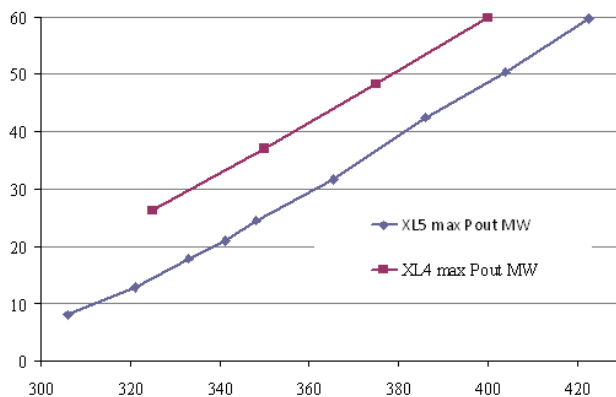

Figure 7: Saturated output power for XL4-12 and XL5-1.

The XL5-1 exhibits no gun or rf oscillations, and spurious modes within  $\pm 1$ GHz from the 11.99 GHz center frequency would appear to be at least -60dB. Both small signal and saturated bandwidths appear to be  $\geq 50$ MHz. Gain curves (Fig. 8) at various voltages indicate consistent performance over a wide range of voltages. The 50MW operating point (duty at 50Hz and 1.5us) can be reached slightly above the design point of 400kV.

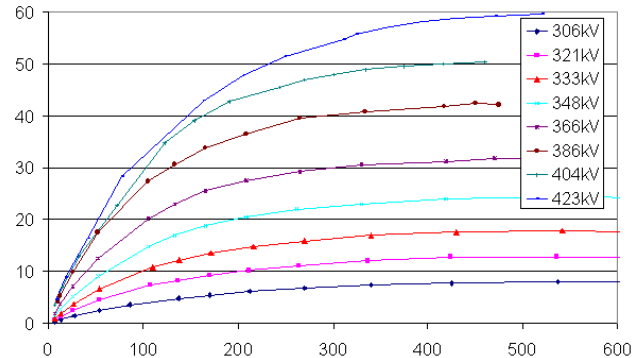

Figure 8: Gain curves for the XL5-1.

The 38% efficiency at the design point may be increased by a change in focusing though a thorough scan of magnet settings but was not completed due to time constraints and issues with breakdown of external waveguide components.

## SUMMARY

The XL5-1 klystron meets all specifications at 404kV except the measured efficiency may be slightly low at 38%. Four more XL5 klystrons are scheduled to be tested over the next year.

## REFERENCES

- [1] George Caryotakis, The X-Band Klystron Program at SLAC, SLAC-PUB- 7146, April, 1996.
- [2] D. Sprehn, Current Status of the Next Linear Collider X-Band Klystron Development Program, 9th European Particle Accelerator Conference (EPAC 2004), Lucerne Switzerland, 5-9 Jul 2004 and SLAC-PUB-11162.
- [3] B. Goplen, L. Ludeking, D. Smithe, and G. Warren, "User-Configurable MAGIC Code for Electromagnetic PIC Calculations," Computer Physics Communications, Vol. 87, Nos. 1 & 2, May 1995, pp. 54-86.
- [4] W. R. Fowkes, R. S. Callin, E. N. Jongewaard, D. W. Sprehn, S. G. Tantawi, "Large Diameter Reduced Field TE01 Traveling Wave Window for X-Band," Proceedings of the 1999 Particle Accelerator Conference, New York, NY, pp. 783-785 (1999).