

## EXPERIMENTAL STUDY OF SPURIOUS MODE IN THE PLS AND PLS-II STORAGE RING VACUUM CHAMBER

Young-Do Joo, Ilmoon Hwang, Chang-Bum Kim, and Sung-Ju Park

Pohang Accelerator Laboratory, Pohang University of Science and Technology, 790-784, Korea

### Abstract

We prove that the noise in the vertical readback from some of beam position monitors (BPMs) in the vacuum chamber of Pohang Light Source (PLS) are caused by the transverse electric (TE) longitudinal harmonic resonances. In the numerical simulation on the PLS vacuum chamber, one of the longitudinal harmonics of TE mode is found at the operation frequency of BPM and the frequency of this mode is matched with the peak frequency in the experimental measurement of RF power transmission through the BPM pickup electrodes.

### INTRODUCTION

The beam position monitor (BPM) [1,2] in the storage ring consists of four pickup electrodes which are coupled to the electron beam in capacitive way. When the electron beam goes through the storage ring beam chamber, the electric potential is induced at the electrodes due to the image charge on the surface of beam chamber. Then the horizontal and vertical position of electron beam is measured by the potential difference between electrodes and is used for beam orbit correction feed-back loop.

However, it has been reported by many workers in several light sources that the sudden step change occurs in the vertical readback from BPMs in some sector vacuum chambers of storage ring. To study the origin of this BPM noise, the resonance eigenmodes inside the vacuum chamber were simulated with simplified chamber structure [3] and experimentally measured using a network analyzer [4]. It was found in those previous works that the transverse electric (TE) longitudinal harmonic modes were responsible for this spurious signal corrupting the BPM outputs. The electric field of TE waveguide mode which is oriented vertically with the magnetic field lines circulating parallel to the beam can explain why only vertical BPM readbacks are affected. It was also studied that the useful signals of the BPMs can be restored by shifting the frequency or damping the strength of resonance TE mode [3-5].

The storage ring of Pohang Light Source (PLS) is not free from this BPM noise either. In the PLS, therefore, the operation frequency of these noise suffering BPMs has been changed from normal value of 500 MHz to 375 MHz with the modified filling pattern which has a blank bucket after every three beam bunches. This temporary solution increases the charge of each electron beam bunches and causes more cost to maintain the additional BPM systems for the different frequency. Furthermore, it is planning to install only two BPMs in a sector chamber

of storage ring of PLS-II, the PLS upgrade project. Therefore, it is significantly requested that we study the longitudinal harmonics of TE modes excited in the PLS vacuum chamber and suggest a method to restore the BPM signals.

In this study, we confirm that the frequencies of longitudinal harmonics of TE mode numerically simulated in the PLS vacuum chamber are matches with the peak frequencies experimentally measured in the RF power transmission test through the BPM pickup electrode. In addition, one of the longitudinal harmonics of TE mode is found at the very close to the operation frequency of BPM in the sector vacuum chamber which contains the BPMs suffering from noise, thereby we prove that the BPM noise in PLS is caused by TE modes.

### BPM VERTICAL READBACK NOISE IN THE PLS STORAGE RING

The time varying profiles of beam current, gap of insertion devices (IDs), horizontal and vertical readbacks of BPM 6, 7, 8, and 9 in the cell 8 on 21, Mar. 2009 is shown in Fig. 1. The position of BPMs is shown in Fig. 2. There are three sudden step changes in the vertical readbacks of BPM. The step 1 may be caused by the change of ID gap, and the step 2 and 4 are caused by the beam injection to storage ring. However, the origin of the step 3 is not clear. Many causes, for instances, ground motion of storage ring, irregular change of current from magnet power supply and electrical misbehaving of BPM boards are considered. At last, it is suspected that the sudden step change in vertical BPM readback is correlated with the resonance modes inside vacuum chamber, because the direction of vertical offset are not uniform in the different BPMs and the horizontal readbacks are relatively quiet. To verify that the origin of BPM noise is resonance mode in the vacuum chamber, the resonance modes near the 0.5 MHz frequency band centered on the 500 MHz where the BPMs are sensitive should be investigated. The large horizontal width of sector vacuum chambers of PLS is required to extract and block synchrotron and to install vacuum components as shown in Fig. 2. Therefore, the beam chamber is connected to the antechamber through the neck with small height and as shown in Fig. 3. The role of neck area is to provide good conductance for vacuum pumping and for transmission of the photons into the beam port. It was well known that the beam-induced transverse magnetic (TM) mode propagates to antechamber through this neck area with small height thus the fields are confined in the

beam chamber with small volume [6,7]. However, the cutoff frequency of TE mode can be lower than 500 MHz because of the extended width of vacuum chamber for the neck area and antechamber. Furthermore, the neck area with a small height introduces a large capacitive loading that lowers the cut-off frequency for TE modes of the chamber in comparison to a rectangular waveguide having the same width. Therefore, it is possible for the harmonic of TE mode to be excited at the operation frequency of BPM.

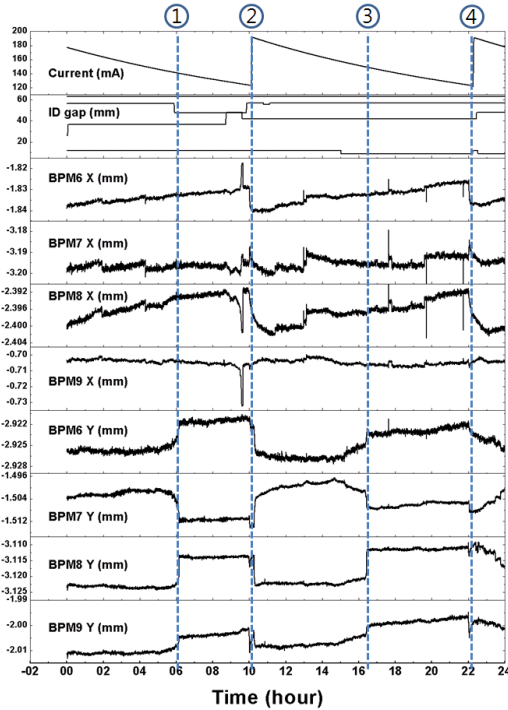

Figure 1: The one day time variation of beam current, gap of insertion devices (IDs), horizontal and vertical BPM readbacks of cell 8 on 21, Mar. 2009.

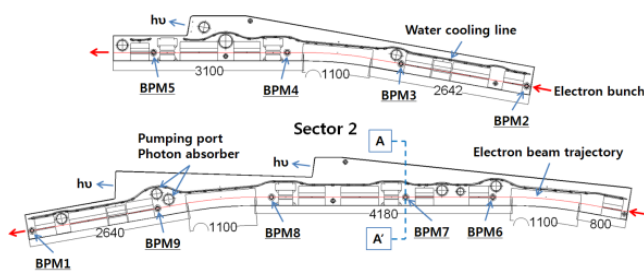

Figure 2: The top-view of the vacuum chamber of a cell of PLS storage ring with positions of BPMs.

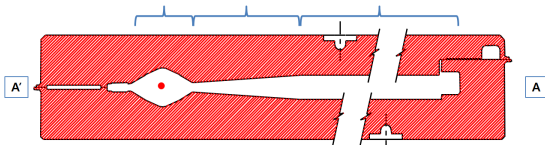

Figure 3: Cross section of normal vacuum chamber of PLS storage ring A-A' line shown in Fig. 2. The length of antechamber varies.

## NUMERICAL SIMULATION OF RESONANCE MODES

The finite-difference time-domain (FDTD) simulation, CST microwave studio (MWS), is used to calculate the eigenmodes excited inside PLS vacuum chamber. The simulation model of sector 2 vacuum chamber of PLS storage ring is shown in Fig. 4. The shape of vacuum inside of vacuum chamber is shown. The vertical photon absorber is also included. We find eigenmodes near the BPM operation frequency and trace by increasing of mesh numbers as shown in Fig. 5. The eigenmode frequencies are converged as the mesh number increases. More than 25 million meshes are used and the simulation time is about 12 hours. There is a suspect eigenmode near BPM operation frequency of 500 MHz. The electric field distribution shows that the electric field is oriented in the vertical direction and it is TE mode.

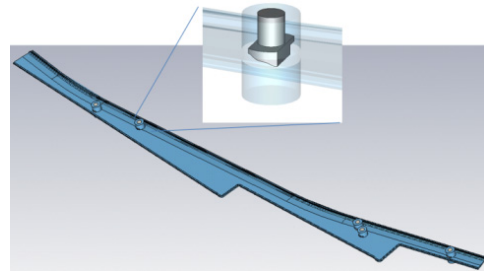

Figure 4: Simulation model of sector 2

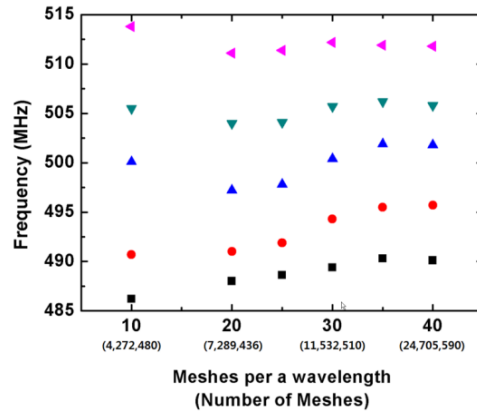

Figure 5: The Simulation result of sector 2

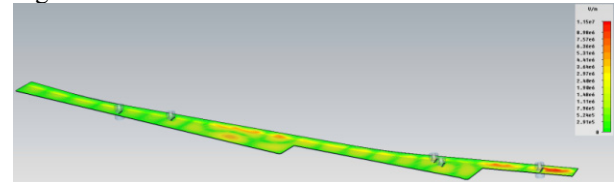

Figure 6: The electric field distribution of the Eigenmode near the BPM operation frequency of 500 MHz. The amplitude of vertical electric field is shown.

## EXPERIMENTAL TEST OF PLS VACUUM CHAMBER

To experimentally investigate the resonance TE modes excited in PLS vacuum chamber, the RF power transmission between BPM ports, without beam, is measured using vector network analyzer (VNA) as shown

in Fig. 7. The signal from the port 1 of VNA is feed to amplifier to get the enough incident power to the beam chamber. Here, to protect amplifier and VNA from reflection power, a circulator and a load is used. It is measured by the power meter that the incident power to BPM port is about 10 watt. Because the incident power to the BPM port is electrically coupled to inside of the beam chamber, the TE mode is excited inside of beam chamber. When the TE mode is arrived at the other BPM port, the pick-up signal is coupled to the port 2 of VNA. Then, we can get the RF transmission parameter, S21, graph in the frequency domain using VNA. The BPM pickup electrodes of BPM 6 and BPM 1 mounted at opposite ends of the sector 2 vacuum chamber are used in the measurement.

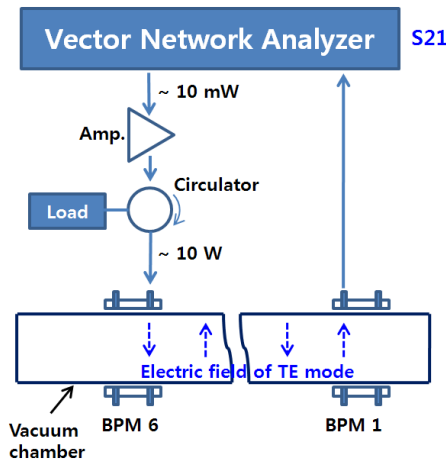

Figure 7: Experimental setup for the measurement of RF power transmission through BPM ports.

Here, we select two cells from the total twelve cells of PLS storage ring. One is the cell #12 where the noise from TE mode is frequently observed and the other is cell #5 where no TE mode noise is observed. The measured S21 graph with sector 2 of cell #12 is shown in Fig. 8. The peak frequencies are matched with those of eigenmodes in the numerical simulation with about 1 MHz differences. These differences are caused by the neglect of strip NEG structure, the assumption of perfect conductor and simplified simulation model.

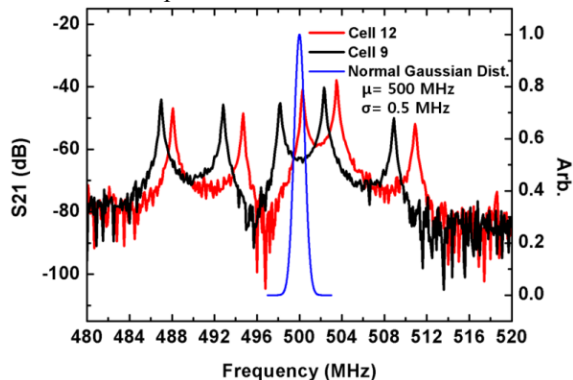

Figure 8: RF transmission parameter (S21) through the BPM ports of BPM6 and BPM1. Normal Gaussian

distribution  $f(x)=\exp[-(x-\mu)^2/(2\sigma^2)]$  with bandwidth of 0.5 MHz centered on 500 MHz are also figured.

The blue line in Fig. 8 means the normal Gaussian distribution with bandwidth of 0.5 MHz centered on 500 MHz which stand for the bandwidth of bandpass filter on the BPM signal board. The S21 graph of the cell 12 seems to be translated from that of the cell 5. The peak for cell 5 is find out of the blue line but that of cell 12 is found inside of the blue line. This explains why the BPM signals of cell 5 are not corrupted by the TE mode but those of cell 12 are corrupted by TE mode. It is clear that the noise of BPM is caused by the spurious TE mode excited in the beam chamber in the PLS from the experimental study above. The reason why frequencies of eigenmodes are different between each cells is under study.

### SUMMARY

It is experimentally verified that the vertical offset noise at the BPM in the PLS storage ring is caused by the TE mode. Based on this study, the design study of PLS-II vacuum chamber to suppress the TE mode will be succeeded.

### REFERENCES

- [1] J. Y. HUANG, "Analysis of Pickup Signals in the Time Domain and the Frequency Domain for the Beam Position Monitor at the Pohang Light Source," J. Korean Phys.Soc. 48, 768
- [2] E. Kahana, "Design of beam position monitor electronics for the APS storage ring," Proc. The 3rd accelerator beam instrumentation workshop, AIP conference proceedings 252, 235-240 (1992).
- [3] Xiang Sun and Glenn Decker, "Eigenmodes in two simplified chamber structures studied for spurious microwaves in the APS storage ring beam chamber," APS internal note, LS-299, (2003)
- [4] Y. Kang, G. Decker, and J. song, "Damping spurious harmonic resonances in the APS storage ring beam chamber," Proc. Particle Accel. Conf. 1999, 3092
- [5] H. Hseuh SR Chambers & RF Bellows ASAC Review of NSLS-II [http://www.bnl.gov/nsls2/committees/ASAC/docs/032609/08%20Hseuh\\_ASAC\\_Mar%2009.ppt](http://www.bnl.gov/nsls2/committees/ASAC/docs/032609/08%20Hseuh_ASAC_Mar%2009.ppt)
- [6] R. Kustom et al., "Analysis of rf modes in the ANL APS vacuum chamber using computer simulation, electron beam excitation, and perturbation techniques," Proc. 1989 IEEE PAC, pp. 1755-1759 (1989)
- [7] R. Wehrle, J. Moenich, S. Kim, and R. Nielsen, "Vacuum system for the synchrotron X-ray source at ARGOONE," Proceeding of IEEE PAC, pp. 1669-1671 (1987)