

A COMPACT RING FOR THE THOMX-RAY SOURCE

A. Loulergue, Synchrotron SOLEIL, Gif-sur-Yvette France

C. Bruni, J. Haissinski, A. Variola, M. Lacroix, M. Jore, T. Vandenberghe, LAL, Orsay France

Abstract

The advantage of X-ray sources based on Compton Back Scattering (CBS) processes is to be able to develop compact devices [1], which can produce an intense flux of monochromatic X-rays. CBS results from collisions between laser pulses and relativistic electron bunches. Aiming at high X-ray flux, one possible configuration combining a storage ring with a low emittance linear accelerator has been adopted by the ThomX project. We present here the main ring lattice characteristics in terms of baseline optics and possible other tunings. In addition, non-linear beam dynamics including Compton and collective effects are presented.

INTRODUCTION

In 2009, the ThomX project was in the Conceptual Design Report phase and entered, since 2010, in the Technical Design Report phase [2]. It is a demonstrator aiming at produce a high X-ray (≤ 50 keV) flux of the order of 10^{13} ph/s and relatively constant over time. The proposed scheme is based on a 3 GHz RF gun linac delivering 1 nC bunches at 50 MeV stored in a compact ring (fig 1) cycled at 50 Hz. The X-ray production occurs at the Interaction Point (IP) where the electron bunches scatter an high energy (~ 20 -30 mJ) laser pulse stored in a Fabry-Perot cavity (table 1). In the first part, we will present the ring lattice optics as well as non linear analysis. This low energy electron beam being very sensitive to various kinds of perturbations, we also investigated the machine impedance as well as intra beam scattering and Compton recoil effects that may drastically spoil the X-ray flux.

RING LATTICE

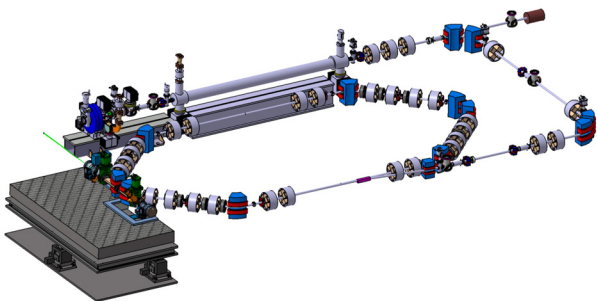

Figure 1 : ThomX general layout (5 x 10 m).

To favour flexibility and compactness, the choice turned into a ring with a tow fold symmetry Double Bend Achromats (DBA) comprising eight dipoles, two long and two short straight sections (Fig. 1) [3].

Table 1 : IP Main Parameters

	Electrons	Photons
Energy	50 MeV	1.06 eV
Charge	1 nC	25 mJ
rms length	25 ps	5 ps
rms size	70 μm	40 μm
Rev frequency	17.8 MHz	35.6 MHz
Col. angle	2 deg.	

This lattice structure has the possibility to accommodate the optical cavity in between the adjacent dipoles of the short straight (0.2 m). Other equipments as RF, feedbacks and injections pulsed elements are accommodated in the dedicated long sections (2 m). The main characteristics are listed in table 2.

Table 2 : Lattice Main Parameters

Nominal energy (Max)	50 MeV (70)
RF Frequency / Harm	500 MHz / 28
Circumference / Rev. Freq.	16.80 m / 17.8 MHz
Betatron tunes (ν_x, ν_z)	3.4, 1.74
Momentum compaction	$1.48 \cdot 10^{-2}$
Natural chromaticities (ξ_x, ξ_z)	-3.2, -8.2
Beta, Disp @ IP	0.1, 0.1, 0 m
Nbr of dipoles/ Families / Field	8 / 1 / 0.5 T
Nbr of Quad / Families / Grad	24 / 6 / 3 T/m
Nbr of Sext / Families / Grad	12 / 2 / 30 T/m ²

The linear optics and non-linear optimization have been carried out with the BETA code [4].

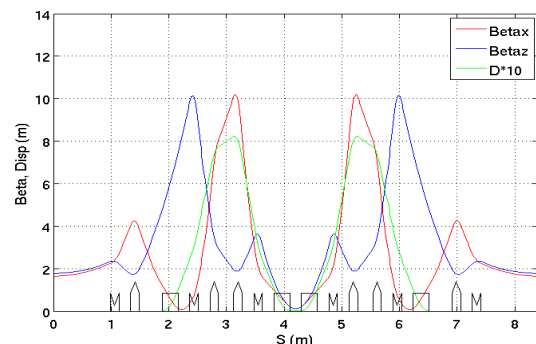

Figure 2: Nominal optical functions .

In a demonstrator strategy, we also favor a ring configuration allowing a large tunes variation (~ 0.5) as well as a large Momentum Compaction Factors (MCF) variation. The later one will be the relevant parameter to

manage the collective effects. The nominal optical functions are plotted in Fig. 2. In addition, attention has been paid in order to maintain a low H function by means of small horizontal beta functions near the dipoles in view of contain the possible emittance increases.

SINGLE BEAM DYNAMICS

Natural horizontal and vertical chromaticities are respectively -3.2 and -8.3. Their corrections are achieved by means of 12 sextupoles (3 families) in the arc dispersive sections. Without any specific optimization and only two sextupole families, the Dynamic Aperture (DA) is already large with 15 mm in both plane in the centre of the long straight where the beta functions are small. The DA may be improved to 20 mm with the three families [5]. With strong quadrupole focusing, ($K \sim 18 \text{ m}^{-2} \text{ max}$), we also investigated the effect of the octupole-like fringe field modeled by the Lee-Whiting kick form [6].

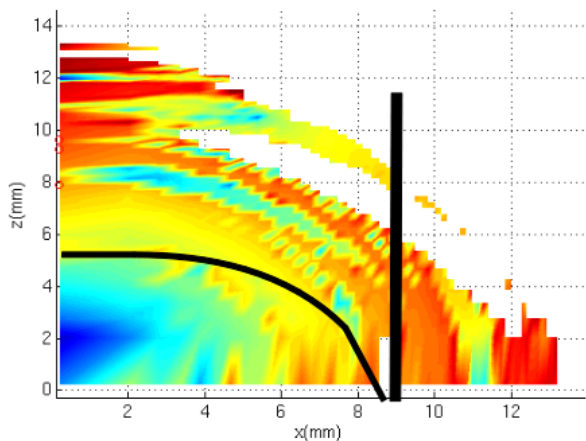

Figure 3: DA including at long straight section centre. Black ellipse is the scaled beam pipe.

The results are plotted via the transverse frequency diffusion analysis in Fig. 3. Tracking is performed using the Tracy II 4th order integrator code [7]. The modelled color code is related to particles tunes diffusion rate [8]. By comparison from model to experience on the SOLEIL storage ring [9], stability limit encloses from blue to yellow colors and losses start to occur from the orange color. The DA is strongly reduced to about 8 mm but the stability frontier is still equal or larger than the scaled beam pipe. This DA limit is also in accordance with the BETA code. With a very short radius (0.352 m), a special attention is done concerning the dipole fringe effect and magnet field tolerances are on the way. In addition, the same analysis in the horizontal versus off energy plane is plotted on Fig. 4. The stability frontier is still equal or even larger than the scaled beam pipe with a maximum energy pipe acceptance of 2.7%. In comparison, the higher order MCF acceptance is ranging from 2.5 to 3.5% depending on the MCF tuning.

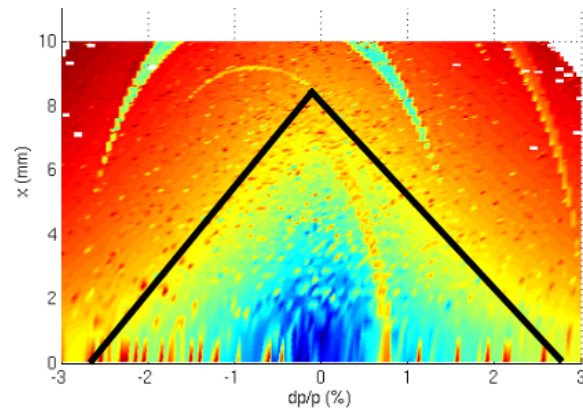

Figure 4: Off momentum DA at long straight section centre. Black straights are the scaled beam pipe.

IMPEDANCE EFFECTS

Another difficulty that is met at low energy is the high sensitivity to wake-fields. As a consequence, a careful design of the vacuum chamber [10], RF cavity tapering and related questions including Coherent Synchrotron Radiation [11] (CSR), Longitudinal Space Charge (LSC) as well as resistive wall (RW) [12] have been investigated. The CSR shielding configuration is not favourable with a short radius (0.352 m) and a large pipe aperture in the dipoles (28 mm) and makes the CSR the dominant longitudinal wake. A dedicated 6D tracking code has been developed including these wake-fields. The tracking is done through the lattice by means of exact transfer mapping limited to perfect hard edge elements [13]. It includes the small radius dipole effects as well as quadrupoles fringe field.

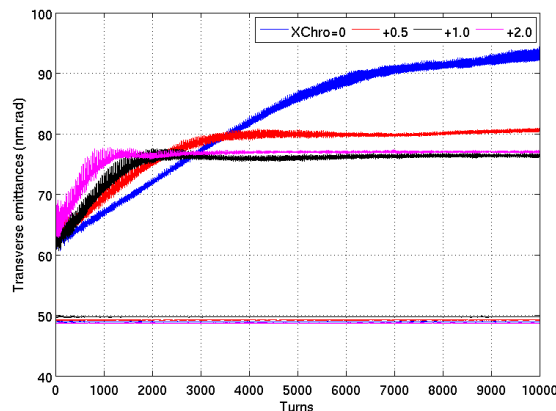

Figure 5 : Transverse emittances versus turns for different chromaticities for 1 nC.

The transverse emittances for 1 nC injected bunch are plotted in Fig. 5 over the first 10000 turns or 0.56 ms for different set of chromaticities. It exhibits that a small positive horizontal chromaticity is necessary for stabilizing the horizontal emittance. In the very first turns, the emittance behaviour has not been fully investigated and understood and is probably connected to the length mismatch with a short injected beam of 4-5 ps rms from the linac. This mismatch progressively disappears over

the first 1000 turns and the bunch length reaches about 25 ps rms.

CBS AND IBS EFFECTS

The electron beam dynamics that prevails in a ring under CBS interaction is similar to the one with Synchrotron Radiation (SR). CBS gives rise to quantum excitation in the transverse and longitudinal planes. It also contributes to energy losses which lead to emittance equilibrium [1]. At low energy, the damping due to synchrotron radiation and CBS is very weak, it entails about 1 second damping time and can be neglected. In the transverse planes, the equilibrium emittance turn out to be those at injection. In contrast, the CBS excitation is much stronger in the longitudinal plane. It gives a significant energy spread increase over 50 ms storage time (Fig. 6) resulting in bunch lengthening. Energy transfer by collision between particles may also gives energy spread as well as emittance during the bunch storage. Based on the lattice parameters, the Touschek life time is of the order of 10 s, large enough as compared to the storage time. In counter part, the multiple Touschek effect (or IBS) plays a significant role. Simulation based on Mtingwa formalism [14] exhibits a large contribution mainly on the horizontal emittance as plotted in figure 7.

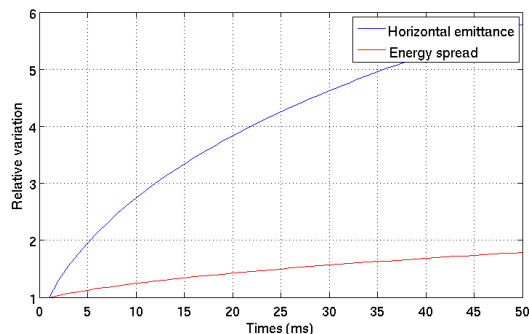

Figure 6 : Relative emittance and energy spread variation with CBS and IBS effect versus time

In summary, we expect up to 50 ms storage by the combined effect of CBS and IBS, an increase of the energy spread by a factor of 2 from 0.3 to 0.6 % and an increase of the horizontal emittance by a factor of 6 from 50 to 300 nm.rad. Including both effects and following the main parameters listed in table 1, the instantaneous X-ray flux is spoiled by a factor of two over the same 50 ms time as plotted in Fig. 7.

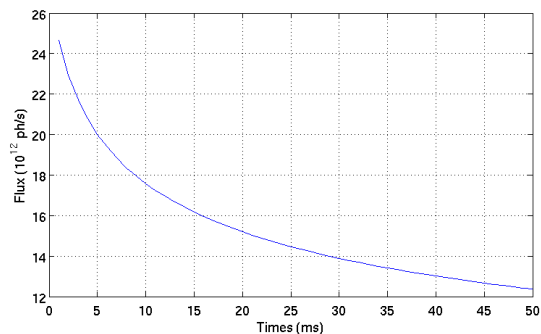

Figure 7 : Estimated flux reduction versus time.

CONCLUSION

We design a compact storage ring with an original CBS interaction scheme located in between dipoles. It offers the advantages to free the long straights sections, to locate the optical mirror outside of the ring and to have the X-ray extraction cone close to IP. In addition, the versatile ring optics will ease the commissioning. Many other points as RF, injection scheme, transfer line, diagnostics, linac, integration, Fabry-Perot laser cavity and feedbacks systems have been investigated or under way but are beyond the scope of this paper.

REFERENCES

- [1] Z. Huang, R.D. Ruth, Phys. Rev. Lett. 80,976 (1998).
- [2] <http://sera.lal.in2p3.fr/thomx>.
- [3] C. Bruni et al. A Compact ring for ThomX-Ray Source, PAC 2009.
- [4] J. Payet, Beta Code, CEA, SACLAY
- [5] W. Scandale, Private talk
- [6] G. E. Lee-Whiting, Nucl. Inst. And Meth. 103, 117, 1972.
- [7] L. Nadolski, Soleil version of Tracy II code.
- [8] J. Laskar, "Frequency Map Analysis and Particle Accelerators", Portland, PAC'03, 2003, pp. 378-382.
- [9] P. Brunelle et al., these proceeding
- [10] R. Nagaoka et al., Recent Studies Of Geometric Impedance at SOLEIL, PAC2006
- [11] J.B. Murphy et al., Longitudinal Wakefield for an Electron Moving on a Circular Orbit, Vol. 57, Part. Acc. 1997.
- [12] K. Bane, M. Sand, The Short-Range Resistive Wall Wakefield, SLAC-PUB, 95-7074.
- [13] L. Nadolski, PHD these report, DAPNIA/SEA-01-02-T, 2001.
- [14] S. K. Mtingwa, African Physical Review 2 (2008) 001.