

# SUPERCONDUCTING MAGNETS FOR SCRF CRYOMODULES AT FRONT END OF LINEAR ACCELERATORS\*

V. S. Kashikhin<sup>#</sup>, N. Andreev, Y. Orlov, D.F. Orris, M.A. Tartaglia, FERMILAB, Batavia, IL 60510, U.S.A.

## Abstract

Linear accelerators based on a superconducting technology need various superconducting magnets mounted inside SCRF Cryomodules. Relatively weak iron-dominated magnets are installed at the front end of linear accelerators. The focusing quadrupoles have integrated gradients in the range of 1-4 T, and apertures in the range 35-90 mm. Superconducting dipole correctors and quadrupoles were designed at Fermilab for various projects. In this paper these magnet designs, and test results of a fabricated dipole corrector, are presented. Also briefly discussed are magnetic and mechanical designs, quench protection, cooling, fabrication, and assembly into cryomodule.

## INTRODUCTION

Superconducting magnets for linear accelerators form a special class of magnets. Such magnets are needed for ILC Main Linac [1], for Fermilab NML facility [2], and Fermilab Project-X [3]. There is some difference in specifications for electron or proton beams. In electron accelerators like ILC, quadrupoles should have magnetic center stability of several microns during strength change by 20%. Because the beam size is less than 1 mm, the magnetic field quality is not an issue. In proton machines the specifications are similar to conventional accelerator magnets, because the beam occupies a substantial part of the magnet aperture. Nevertheless, all of these magnets should be precisely mounted inside SCRF cryomodules, and generate during operation less than 10 μT fringe field in SCRF areas.

## QUADRUPOLES

Superconducting quadrupoles at the front end of a linear accelerator should be relatively strong and compact, so a focusing/defocusing doublet is required. The apertures of these magnets are in the range of 40-90 mm diameter, where the smaller aperture quadrupoles are for use in FNAL Project-X, and larger apertures are specified for ILC and NML.

### Quadrupoles with Racetrack Coils

The magnet design parameters are shown in Table 1. The quadrupole design and fabrication have used the same technology as was successfully tested for ILC Main Linac Quadrupole [1]. Each quadrupole has four racetrack coils wound from 0.5 mm diameter NbTi

superconductor. The laminated iron core shapes the field in the magnet aperture and effectively shields fringe fields. Ferromagnetic field clamps are installed at both magnet ends and in the doublet middle to reduce the end fringe fields and eliminate influence between focusing and defocusing magnets (See Fig. 1).

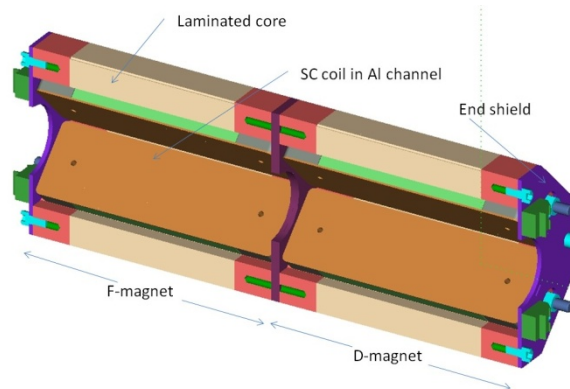

Fig. 1: Quadrupole Doublet for NML (half is shown).

Each racetrack coil has two additional sections connected in series to form the vertical and horizontal dipole correction fields. A heater, wound on the outer surface of coils, can be powered from an external power source when a quench is detected. During a quench, the stored magnetic field energy is dissipated in coils, Al channel, and external dump resistor, to avoid overheating the coil and quenching neighbouring SCRF cavities. The 3D magnetic field analysis (See Fig. 2 – Fig. 4) confirmed that this magnet has acceptable parameters.

Table 1: Quadrupole Doublet Parameters

Parameter	Unit	Value
Beam pipe OD	mm	78
Integrated strength	T	3.0
Distance between quadrupole centers	m	0.3
Integrated dipole corrector strength	T-m	0.01
Quadrupole field quality at 5 mm radius	%	< 0.5
Dipole field homogeneity at 5 mm radius	%	< 5
Peak coil ampere-turns	kA	15
Operating temperature	K	2

\*Work supported by US Department of Energy

<sup>#</sup>kash@fnal.gov

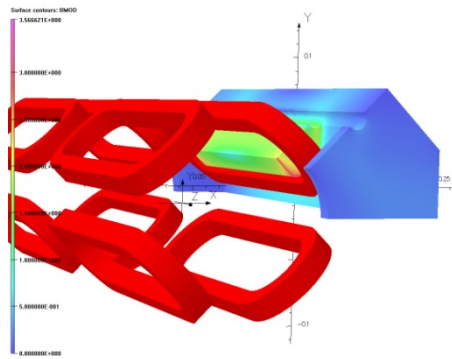

Fig. 2: Quadrupole Doublet 3D calculation model and flux density distribution in the iron yoke.

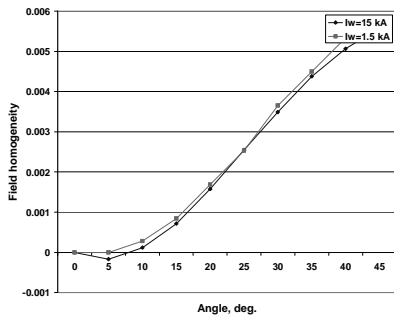

Fig. 3: Quadrupole Doublet integrated field homogeneity at radius 5 mm.

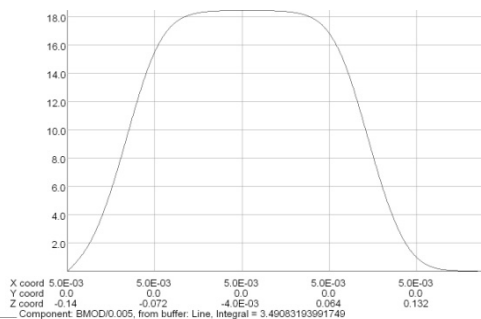

Fig. 4: Quadrupole Doublet field gradient distribution for the single magnet at 15 kA total coil current.

Operating in the range of 1.5-15 kA -turns total coil current will generate 0.35-3.5 T of integrated gradient with field quality of  $\pm 0.3\%$  in the 10 mm diameter area. Quadrupoles with smaller apertures could be obtained by a scaling down of proposed magnet.

*Quadrupoles with Circular Coils*

Because accelerator front ends have very tight space limitations, compact focusing elements are needed. A compact quadrupole design with circular coils (See Fig. 5) was investigated in [4] where the possibility of using such magnets was shown. As an alternative to superconducting solenoids in the low energy linac sections, a number of short quadrupole sections like that shown in Fig. 5 could be assembled in a single long unit generating larger magnet strength. The version of quadrupole with two sections is shown in

Fig. 6, and calculated parameters are in Table 2. It should be noted that the strength of this type of quadrupole is limited by saturation of iron flux return parts.

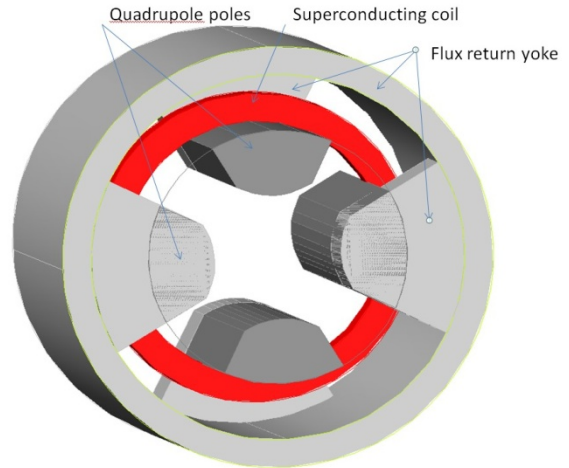

Fig. 5: Quadrupole with a circular coil.

Table 2: Quadrupole Parameters

Parameter	Unit	Value
Beam pipe OD	mm	45
Integrated strength	T	2.97
Quadrupole length	m	0.24
Peak coil ampere-turns	A	6
Peak field in the coil	T	0.42
Effective length	m	0.236
Outer yoke diameter	m	0.2
Operating temperature	K	2

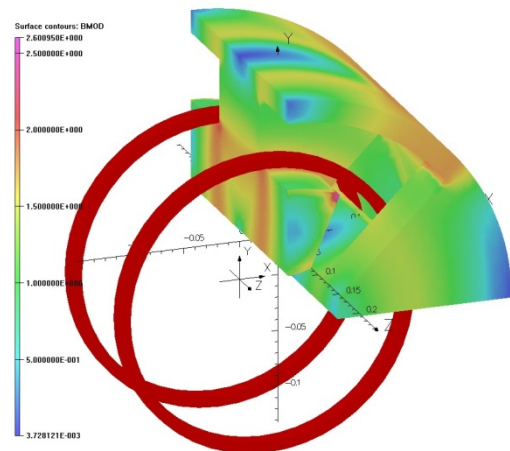

Fig. 6: Quadrupole Doublet flux density distribution in the iron yoke.

## DIPOLE CORRECTORS

The corrector package for NML is based on the TESLA Test Facility magnet package design [5]. The corrector cold mass dimensions were defined by the LHe vessel, beam pipe, and conduction cooled current leads. The dipole field is generated by single layer shell-type windings laid on the beam pipe outer surface as shown in Fig. 7. The main difference between TESLA and this corrector is an outer Al collar tube. This tube forms a closed mold for epoxy vacuum impregnation of the whole package, and provides coil pre-stress during cooling down.

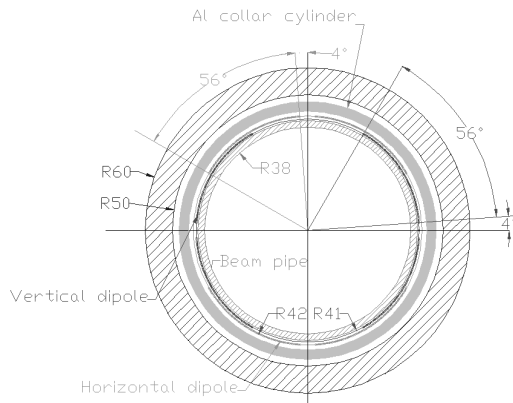

Fig. 7: Dipole corrector cross-section.

This dipole corrector was fabricated at FNAL (See Fig. 8) and successfully tested [6]. The peak magnetic field in the soft iron yoke is low enough (about 0.85 T at 100 A) that iron saturation is not a problem. At 100 A the peak field on the coil is only 0.3 T, and peak field in the bore is 0.2 Tesla. The design achieves the required integral strength at about 25 A, and thus has plenty of operating margin. An OPERA3D model predicts the integrated field uniformity at the radius of 5 mm to be 0.14 %.



Fig. 8: Dipole corrector coils.

The series-powered vertical dipole (VD) plus horizontal dipole (HD) windings were ramped to 100A without a spontaneous quench. Quenches were induced using spot heaters to study quench development and protection at currents from 10 A to

100 A. Both dipole magnets performed well to this level, and demonstrated that heater protection is not necessary if a dump switch and resistor are used for energy extraction. A test of self-protection, with no dump or heaters, was not attempted for this device.

Magnetic field measurements (See Fig. 9) were performed at currents ranging from 10 to 100 A using a 3D Hall probe. The field profiles and fringe field strength of a few Gauss are in good agreement with model predictions, and showed very good linearity.

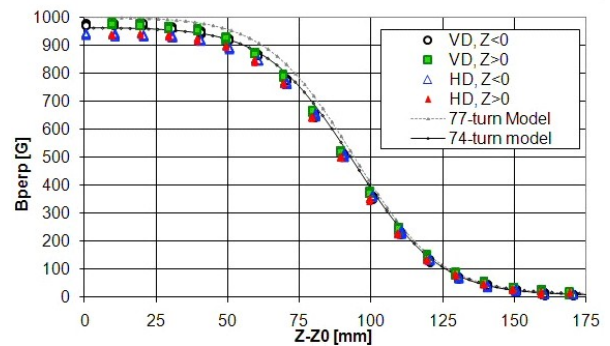

Fig. 9: Measured and calculated field profiles at 50 A.

## SUMMARY

The design, fabrication, and testing of small quadrupole and correction dipole magnets for front end superconducting linacs are now in progress at Fermilab. These small magnets have tight specifications related to the fringe fields, small allocated space, and positioning inside SCRF cryomodules. Special attention must therefore be paid to their design, manufacturing technology, and tests.

## REFERENCES

- [1] V. S. Kashikhin , *et. al.*, "Test Results of a Superconducting Quadrupole Model Designed for Linear Accelerator Applications", *IEEE Transactions on Applied Superconductivity*, vol. 19. Issue 3, Part 2, June 2009, pp. 1176-1181.
- [2] "NML- New Muon Lab", Fermilab, 2009. <http://apc.fnal.gov/ARDWS/NML.html>
- [3] "Project-X Draft Report from the ICD-2 Research Program", FNAL, October 2, 2009. [http://www.fnal.gov/pub/projectx/pdfs/ICD\\_2\\_Research\\_Program\\_Task\\_Force\\_v6.pdf](http://www.fnal.gov/pub/projectx/pdfs/ICD_2_Research_Program_Task_Force_v6.pdf)
- [4] V. Kashikhin, "A Novel Design of Iron Dominated Superconducting Multipole Magnets with Circular Coils", MT21, China, October 2009, *IEEE Transactions on Applied Superconductivity* (to be published).
- [5] "The European X-Ray Free-Electron Laser. Technical Design Report", DESY 2006-097, July 2007.
- [6] N. Andreev, et al., "Fabrication and Test of Corrector Dipole Package ILC\_CM2\_Dipole\_01," FNAL Tech. Div. note TD-10-003, Feb. 2010.