

Compact and cheap systems for transport proton and ion beams between of medical accelerator and fixated horizontally patient at many directions.

M. Kats ITEP

Mark.Kats@ITEP.ru

Introduction.

Modern transport systems.

Two versions of GANTRY.

New solutions are necessary!

2 directional solutions – not so good!

Compromise requirements to treatment equipment.

New solutions are possible!

1. Ex - centric GANTRY.

2. Planar systems.

Simple Planar System - SPS(F)

New Planar System (NPS)

3. Systems with super conducted magnets.

Conclusions.

Introduction.

There are a lot of new cancer patients in any countries in each year (in Russia like 200000). Therapy by proton and ion beams is very useful for them. But less 1% of patients are treated by this modern method now by reason of its high cost.

What is an aim of irradiation? All parts of a target (with complex spatial shape) must be irradiated by constant medical dose. Simultaneously healthy parts of the body must be irradiated by minimal doses.

What are preferences of proton and ion beams?

By such way minimal doses in healthy parts of the body are possible.

By such way sharp boundary of doses distribution between of the target and significant healthy organs is possible.

Ion beam with its high ionization density can be used additionally for treatment of most dangerous cancer.

Medical accelerator is the main part of equipment for such therapy.

But any known systems of optimal transport beams to a few rooms with GANTRY are very large and expensive. They spend more than half of entrance into building and costs. They are one of a brake at introducing proton and ion therapy.

Modern transport systems.

Accelerator with extracted useful beam, channels for transport beam to a few treatment rooms, equipment for choose optimal direction of the beam (GANTRY) with its system for optimal spreading doses through the target volume, treatment table with horizontally fixated patient.

The target is fixated in center of irradiation. Optimal spreading system used 3d scanning. GANTRY is magnet channel fixated on rotated frame with horizontal axis of rotation. This axis pass through direction of input beam and pass through center of the target. **GANTRY is universal and optimal system according of all medical requirements for each treatment rooms.**

NPTC, Boston, USA, (by IBA)

2 GANTRY for any targets, one horizontal beam for targets into a head (<10%).

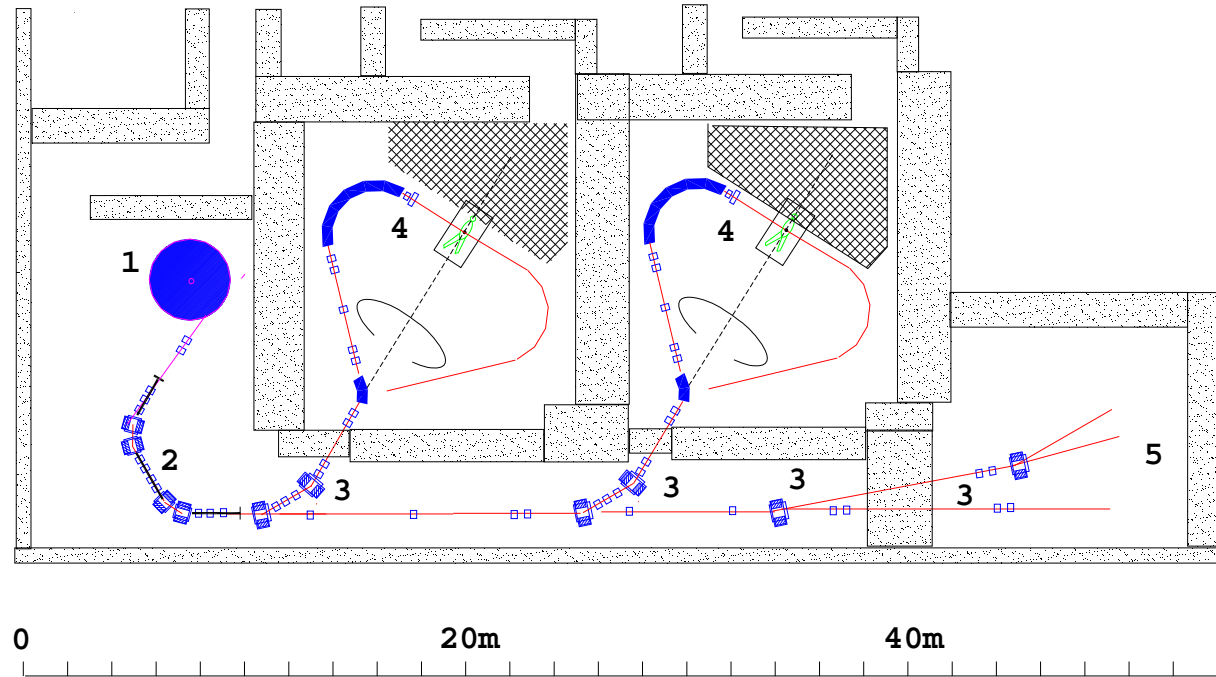

Today like 10 similar centers for proton therapy are in working conditions and like 10 new facilities will be build soon.

Like 300 patients can be treated in each room per year.

Time of the patient precision fixation on treatment table 5 times more than time of irradiation.

Near each accelerator for its high productivity 5 treatment rooms with 4 GANTRY are useful.

It is layout of MPTC, Munich, 2007.

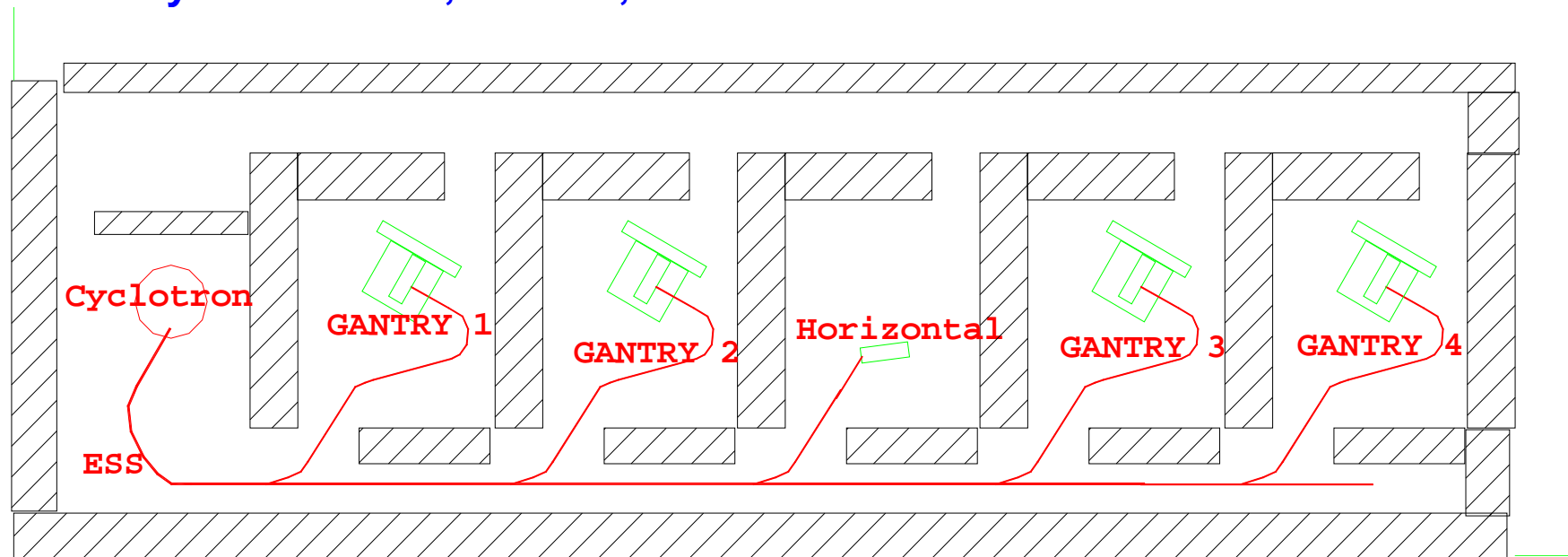

It can see – transport systems used more than 50% volume into building, power and cost of main equipment even at proton beam.

**For 30cm range into the patient body energy protons must be near 230MeV.
They can be turned by usual magnetic field 1.6Tl with radius like 1.5m.**

**Radius of ions movement at the same range and into the same field is like 4m.
Therefore all equipment (accelerator and transport systems) for ion beams are
bigger and much more expensive in comparison with systems for proton beam.**

But part of cancers can be treated only by ion beam.

Therefore centers with ion beam are very useful.

Two versions of GANTRY.

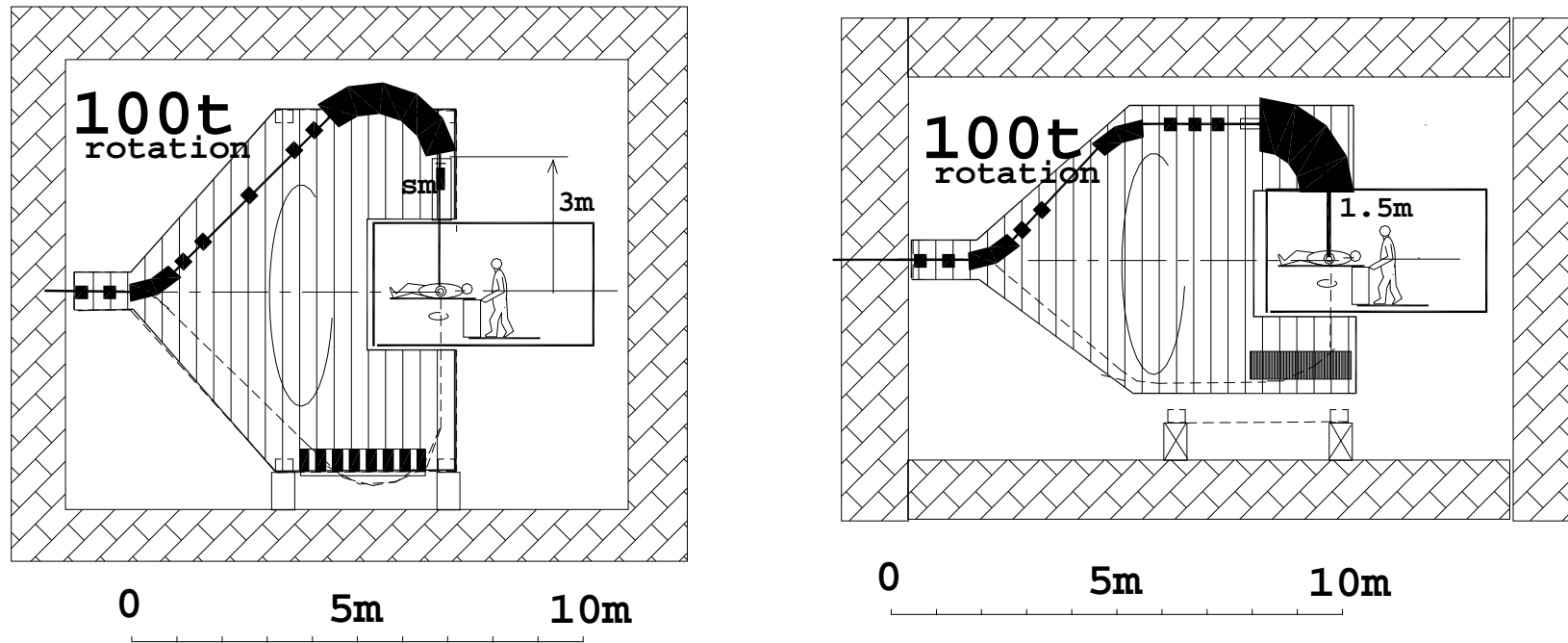

1. **Spreading system** for proton beam can be placed on total distance like 3m **after the last bending magnet**. It is possible to use both active (3 directional scanning) or passive (scattering and collimation) systems. Sizes of similar rotated GANTRY system for proton beam are like 11m^3 . They can not be decreased. Radius rotation of heavy magnet and its counter weight is like 4m. For its precision rotation heavy rigid frame is necessary and total rotated weight of proton GANTRY is like 100T.

Spreading system for ion beam need more then 5m. Therefore similar design is not useful for ion beam.

2. After scanning magnets particles pass through gap of the last magnet. Directions of the beam after magnet are near to parallel to channel axis (scanning at large distance). **It is the best conditions for scanning.** But by such way sizes of the gap of the last magnet are the same, as sizes of maximal target (like 200mm*200mm). Therefore last magnet has very large weight and cost. It used a lot of power. Total sizes, weight of rotated equipment for proton and ion beam are (L=11m, D=8m, 100T). **Properties of similar GANTRY depend mainly on the last magnet. They depend on phase volume of the beam slowly.** It is impossible to decrease its sizes, weight and cost. According of medical requirements and opinion similar GANTRY is the best. **It was build in HIT, Heidelberg, 2008. Its parameters are (L=19m, D=15m, 600T).**

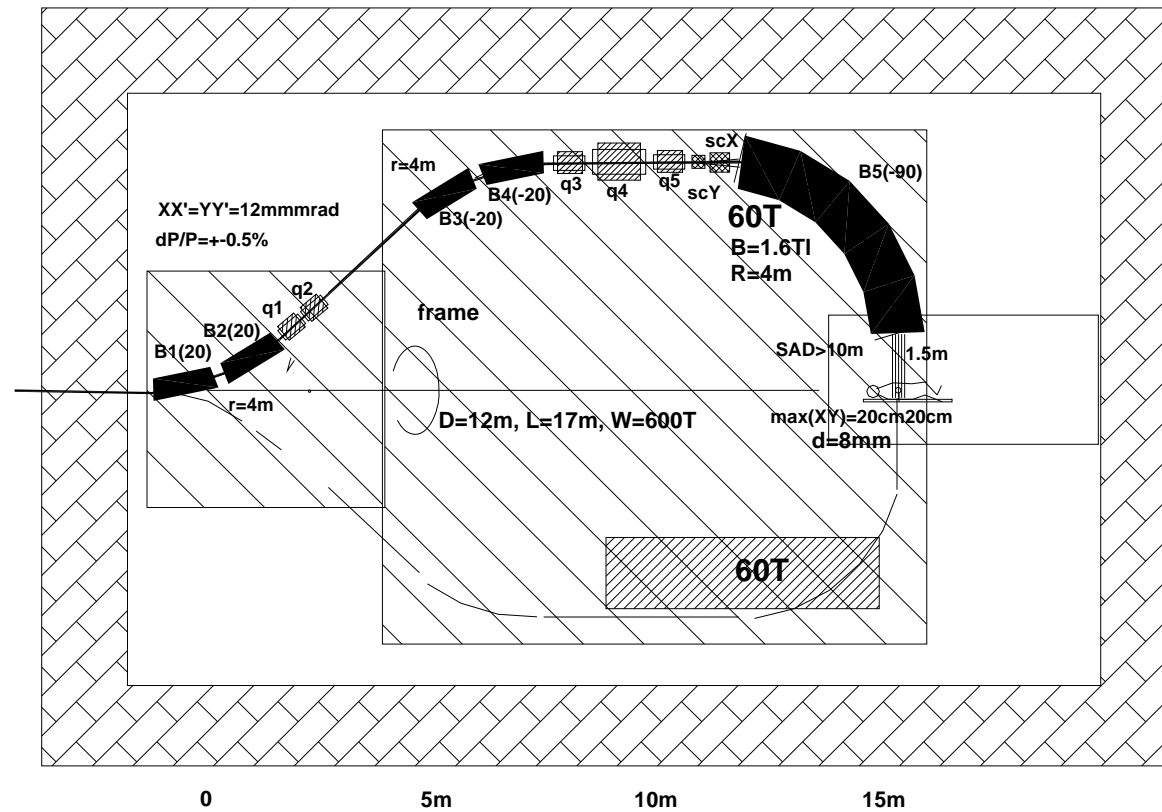

Cost and sizes of similar GANTRY for ions are so high, that only one treatment room in HIT was equipped with GANTRY.

Therefore today a few last projects centers of treatment by ion beam in Germany and in Japan searched versions without GANTRY, with a few rooms with horizontal beams only and with one room with vertically bended beam. It is not optimal system, but it is much simple, cheaper, smaller.

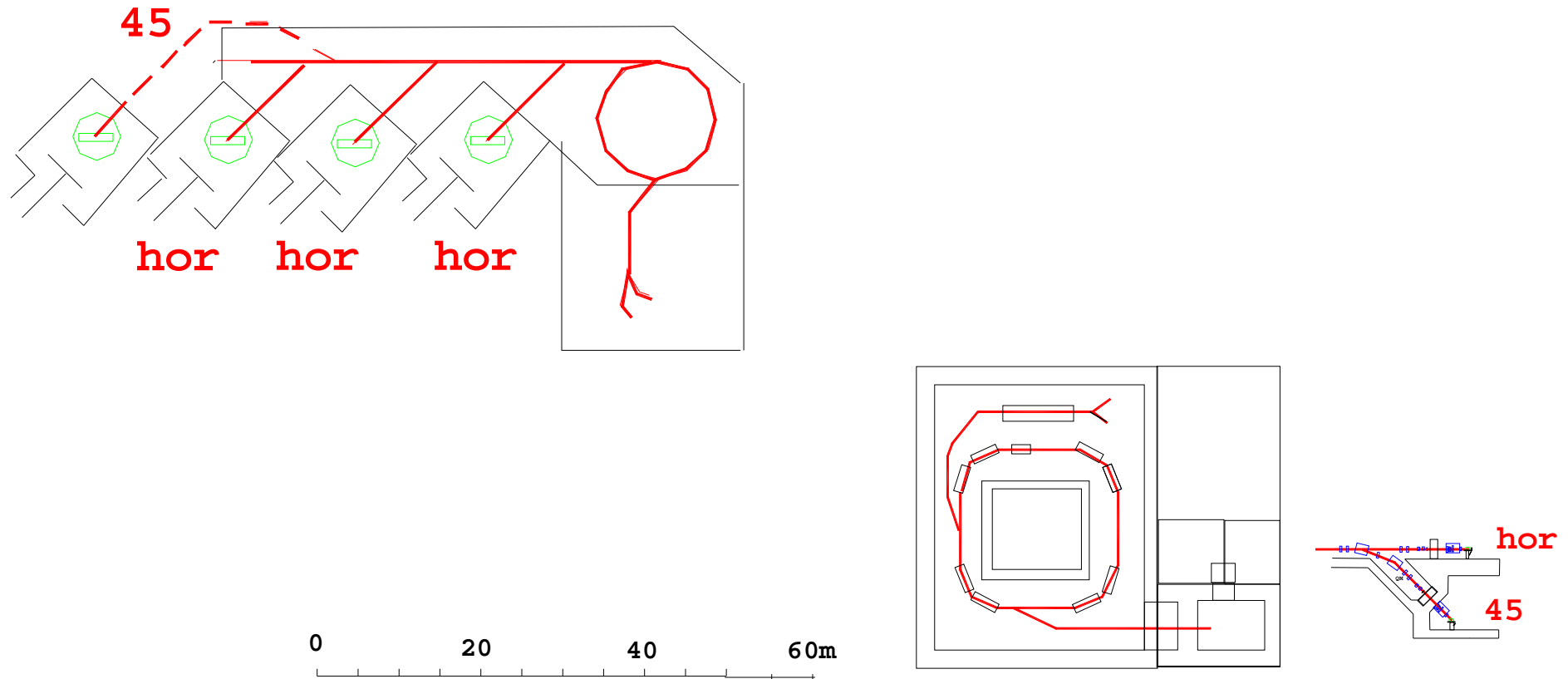

Take in account significance of both accelerator, diagnostic system, planning soft, systems of patient fixation and so, it is necessary to search possibility of new systems for transport proton and ion beams, more small, simple, and cheap, without losing properties of irradiations.

**Aim of my work –
design of new systems with significant decreasing of its sizes and cost.**

Compromise requirements to treatment equipment.

1. In order to use optimal directions of irradiation **many spatial directions must be accessible, but ALL spatial directions (like in GANTRY) are NOT necessary.** Probably optimal quantity of directions for each fraction is 2 or 3, but both of them must be optimal.
2. **Directions of irradiation in different fractions can be different.**
3. For minimal irradiation of healthy parts of the body doses distribution through the target volume must be done by active **3d scanning** at significant distance between scanning magnets and the target with take into account movement of the body parts.
4. For most effective using of complex and expensive equipment, for decreasing time, when patient is placed into treatment room, it is useful **to fixated patient on plate with precision tomography into additional room.** Plate can be fixated on treatment coach with high precision. **By such way irradiation of patient into each fraction can be possible in a few position of treatment table, in a few rooms without additional precision measurement.**

New solutions are possible by three ways.

1. EX - CENTRIC GANTRY

With aim of simplification of precision rotation of heavy system around of horizontal axes it was suggested systems with **magnets rotation around of horizontal axis, which pass through center mass of all magnetic channel.** In such design no counter weight, diameter of rotated heavy equipment is near to radius of particles bend into magnetic field. Fixated horizontally patient is moved on beam direction around of the same horizontal axis, around of magnets. **Diameter of heavy rotated equipment is near to radius of bend particles into field of the last magnet (like 2m for proton beam, like 4m for ion beam).**

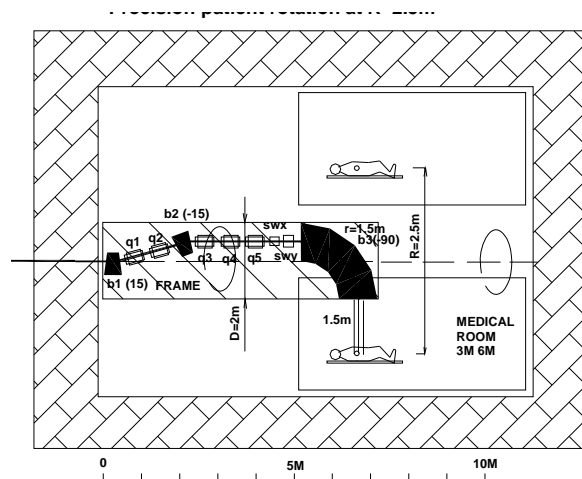

Ex - centric GANTRY for proton beam

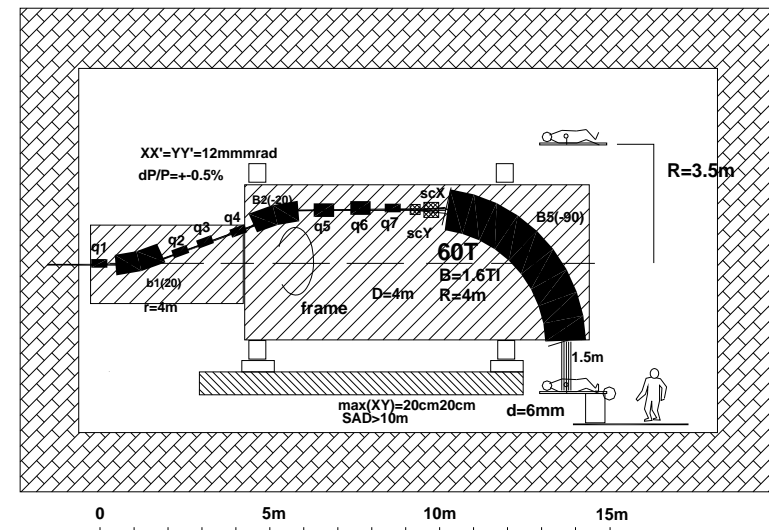

Ex - centric GANTRY for ion beam.

2. PLANAR SYSTEMS

In any “planar systems” beams are bended by immovable magnets in vertical plane only. Fixated horizontally patient is moved with precision by treatment coach on beam direction.

Simple Planar System - SPS(F)

Immovable magnet is placed additionally just before of the patient instead of GANTRY into treatment room with usual horizontal beam. This magnet has large gap (like 200mm) and it can turn beam only in vertical plane at any angles to horizontal plane which less F ($-F < f < F$). Patient is fixated horizontally by usual devices. At change direction of the beam patient is moved by treatment coach slowly with precision in vertical plane on beam direction. Angle F is a subject of compromise. As bigger F as close possibilities of SPS(F) to possibilities of GANTRY, but as heavy magnet, and as higher its power, and as bigger displacements of patient.

Similar system is able to improve significantly abilities of usual treatment rooms with horizontal beam even at small F .

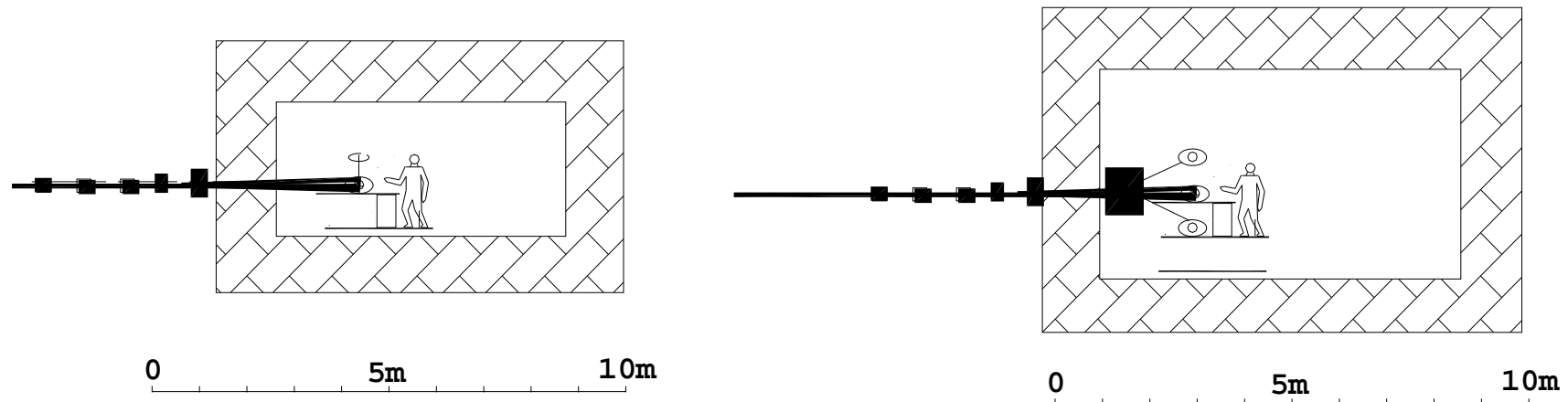

Schemes of treatment rooms with horizontal beam

with SPS(F).

SPS(F) has two physical defects: linear dispersion in vertical plane at the target is not zero, and it is impossible to use for irradiation directions from the top and bottom cones. **Both defects are not so significant for most of patients. In comparison with any GANTRY SPS(F) is very simple, very small, and very cheap.**

Comparisons of abilities of different systems.

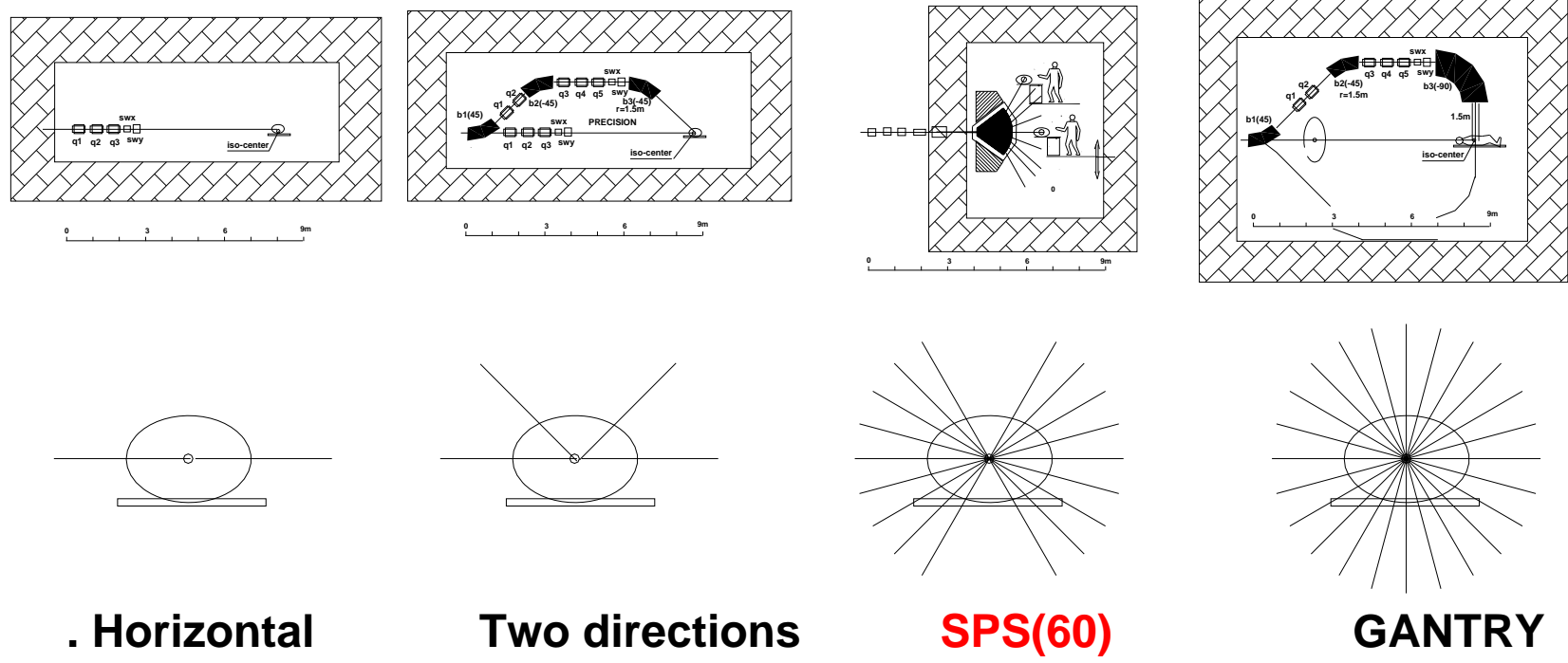

It can see, that abilities of SPS(60) are similar to abilities of GANTRY, and they are much better in comparison with horizontal beam or equipment with two direction.

Properties of SPS can be improved by preliminary bend of the beam in vertical plane (It is possible to choose optimal spread of directions for irradiation $(F+A>f>F-A)$ and to decrease linear dispersion).

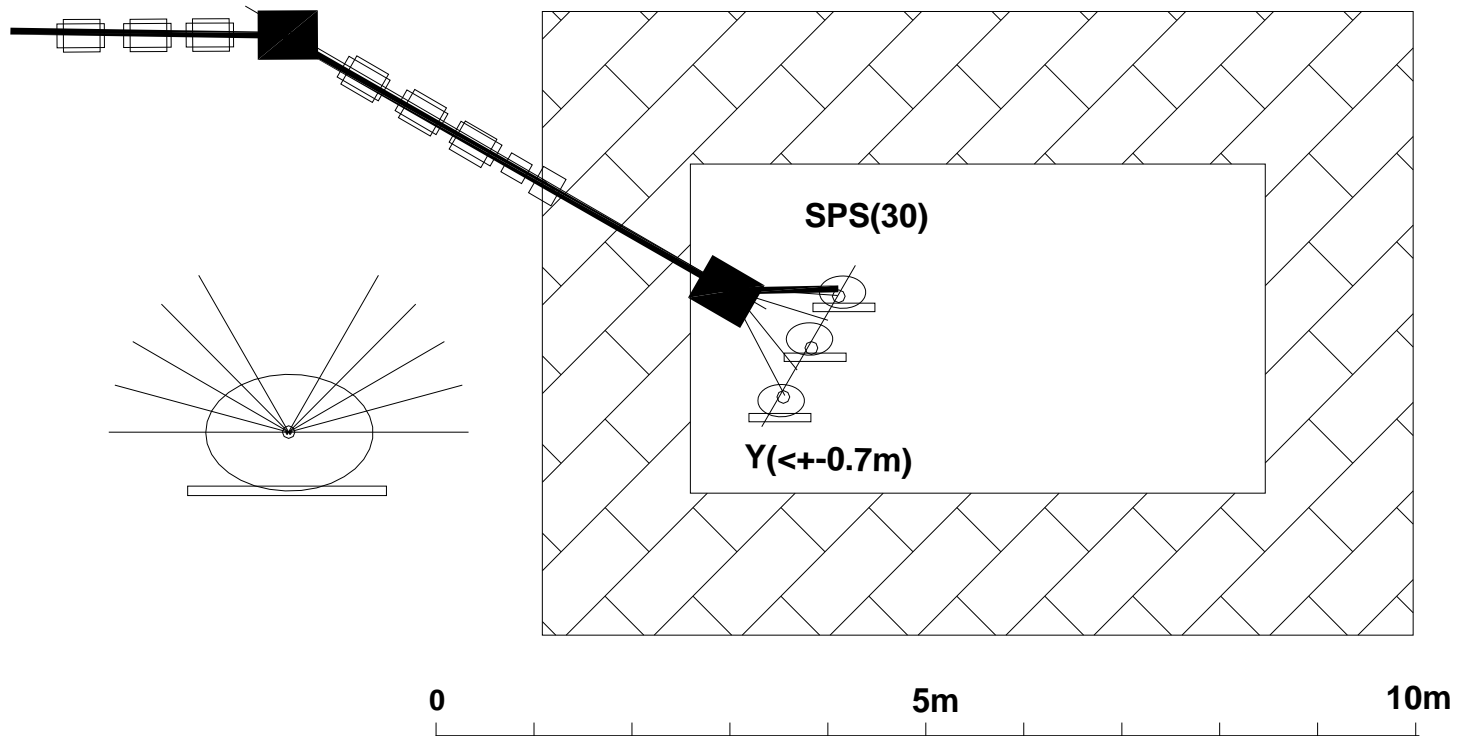

Scheme of SPS(F) with preliminary bend off the beam in vertical plane.

New Planar System (NPS)

New Planar System can work both instead of system of transport beam to a few treatment rooms, and instead of GANTRY into each room. Treatment rooms are placed on a few vertical levels. System of preliminary bend of the beam can transport beam to any one room. SPSs with small F are placed into each room. Each SPS is oriented on initial direction of the beam for this room. Therefore each room has its own spread of directions for irradiation. But any spatial directions can be used for treatment in many fractions at using abilities of all.

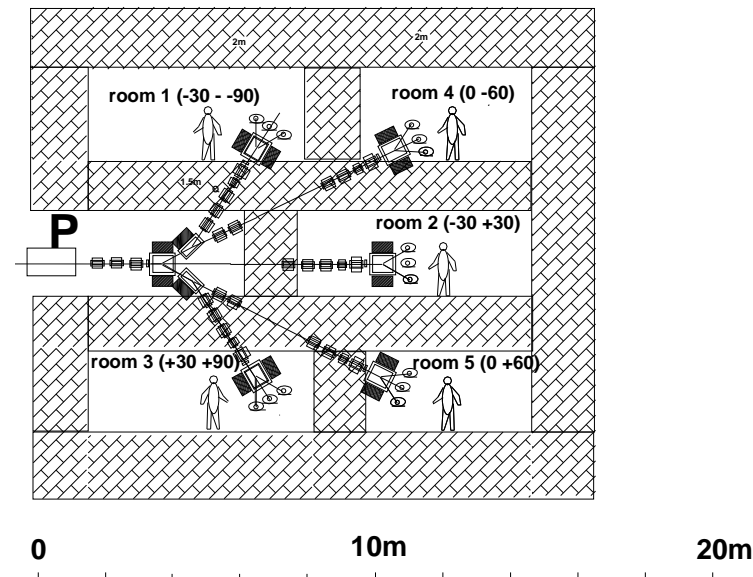

Vertical cross sections of NPS for protons.

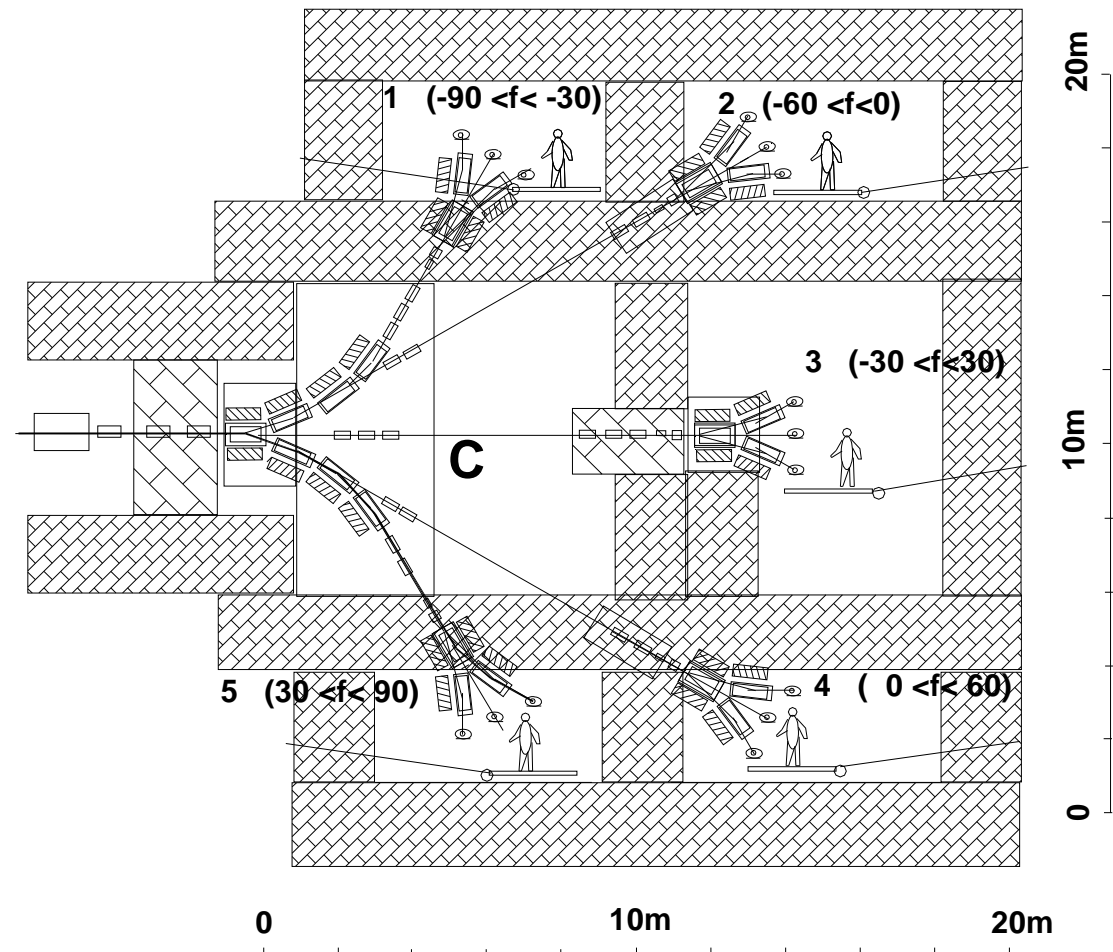

Vertical cross sections of NPS for ions.

Both systems are very compact and any spatial directions can be used for irradiation. No rotation or displacement of heavy equipment. Magnets for preliminary bends of the beam have small gaps. At $F=30$ degrees gaps of magnets for SPS are not so big. Displacements of patients are less $\pm 1.5\text{m}$.

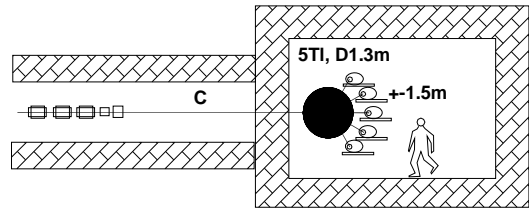

SPS(60) for ion beam with 5Tl magnet.

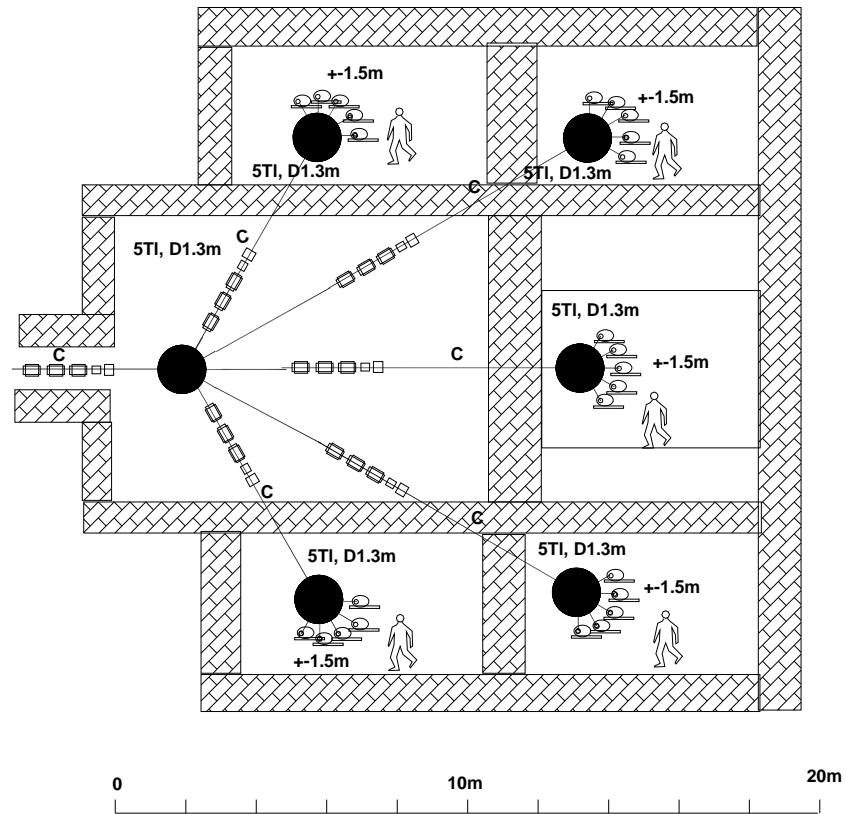

New planar systems with 6 similar 5Tl magnets.

All shown schemes can to use active 3-d scanning systems for doses distributions.

They are especially useful at transport of ion beam.

All of them can be designed without any significant mechanical or magnets difficulties.

All schemes were supported by optical calculations with TRANSPORT.

Beams with phase volume up to $15\text{mm} \cdot \text{mrad}$ (like after cyclotron with ESS system) can be transport through those systems successfully.

CONCLUSIONS

Today equipment for transport beam between accelerator and patients have so large sizes, weight, cost, that it is significant brake for introduce proton and ion beams in mass treatment. **But equipment for transport medical beams can be designed according of new ideas with much less sizes, weights, costs, without significant defects in its properties.** It is equipment for treatment, not for experiments. **It is a way for increasing year productivity of each medical accelerator.**

Ability of each existing treatment room with horizontal beam can be improved significantly by installation of additional magnet for bend the beam in vertical plane and by increasing of possible vertical displacement of patient (SPS) by treatment table.

It is necessary to use new solutions of proton and ion beam transport at design of all future centers for beam therapy independent on accelerator.

Thank you for attention!