

A NEW METHOD OF RF POWER GENERATION FOR TWO-BEAM LINEAR COLLIDERS

H. Braun, R. Corsini, T. D'Amico, J.P. Delahaye, G. Guignard, C. Johnson, A. Millich, P. Pearce, L. Rinolfi, A. Riche, D. Schulte, L. Thorndahl, M. Valentini, I. Wilson, CERN, R. D. Ruth, SLAC

Abstract

In this paper we discuss a new approach to two-beam acceleration. The energy for RF production is initially stored in a long-pulse electron beam which is efficiently accelerated to about 1.2 GeV by a fully loaded, conventional, low frequency (~1 GHz) linac. The beam pulse length is twice the length of the high-gradient linac. Segments of this long pulse beam are compressed using combiner rings to create a sequence of higher peak power drive beams with gaps in between. This train of drive beams is distributed from the end of the linac against the main beam direction down a common transport line so that each drive beam can power a section of the main linac. After a 180-degree turn, each high-current, low-energy drive beam is decelerated in low-impedance decelerator structures, and the resulting power is used to accelerate the low-current, high-energy beam in the main linac. The method discussed here seems relatively inexpensive, is very flexible and can be used to accelerate beams for linear colliders over the entire frequency and energy range.

1 INTRODUCTION

The CLIC study focuses on high-gradient, high-frequency (30 GHz) acceleration for multi-TeV linear colliders. Unfortunately, there are no conventional high peak power RF sources at 30 GHz. This leads naturally to the exploration of the two-beam acceleration technique[1,2], but many features of conventional RF systems can be used in two beam accelerators.

In conventional methods of RF power production, the klystron is the most common power source. The SLAC klystrons produce about 65 MW at 2.856 GHz with 3.5 μ s pulses. The NLC klystrons operate at 11.424 GHz and produce about 75 MW with about 1.5 μ s pulses. In both cases, RF pulse compression is necessary to achieve the higher power necessary for high gradients. It is possible to compress the RF pulse by delaying the earlier part of the pulse to create a shorter pulse that is higher in power. This can be done with a SLED system (LIPS at CERN), a SLED II system with delay lines, or a binary compression system.

Another method of compression (developed at KEK), the Delay Line Distribution System, uses a different approach. After 3-dB combination, the power of several klystrons can be switched, by using the relative phases of the klystrons, to different waveguides for distribution to

the accelerator. If the power is distributed in low-loss waveguides opposite to the direction of the electron beam, a single RF pulse can power several widely spaced sections in the linac. It is necessary to overlap several of these systems to completely fill the linac.

With two-beam accelerators, the methods discussed above are also extremely useful, but in this case the compression and distribution are done with electron beams that later generate RF locally in a decelerator structure just before the high-energy electron beam arrives.

2 CLIC PARAMETERS

Several sets of RF parameters for the CLIC design are shown in Table 1[3]. To illustrate the drive beam issues consider only the 3 TeV set. The total stored energy in each high-energy beam is 144 kJ per pulse. With a 27% RF to beam transfer efficiency, the necessary RF energy per pulse is 540 kJ. With about 67 % transfer efficiency from the drive beam to RF, we need 800 kJ in the drive beam for each linac, each pulse.

Table 1: RF parameters for CLIC designs

Beam param. at IP	0.5 TeV	1 TeV	3 TeV	5 TeV
Rep. Rate (Hz)	200	150	75	50
$10^9 e^\pm$ / bunch	4	4	4	4
Bunches / pulse	150	150	150	150
Bunch spacing (cm)	20	20	20	20
Accel. gradient (MV/m)	100	100	150	200
Two linac length (km)	7	14	27.5	35
Accelerating Sections	10802	21604	43736	54802
Power / section (MW)	116	116	231	386
AC to beam effic. (%)	14.2	14.2	10.6	7.8
AC power (MW)	68	102	206	310

3 TWO-BEAM CONFIGURATIONS

The simplest configuration for a two-beam accelerator consists of a single low-energy, high-current drive beam travelling parallel to, and transferring energy to, a high-energy, low-current beam[4]. The length of the drive beam is equal to the length of the desired RF pulse. To have the correct stored energy, a 10 GeV beam with a pulse length of 120 ns would need a current of 670 A. If the beam were comprised of 1800 bunches spaced by 2 cm; each would have 45 nC of charge. It is quite difficult to create and accelerate such a beam because all the energy is stored in a 120 ns time interval.

To consider an alternative approach, let us first imagine that we use multiple beams rather than one beam to store the energy[5]. For example, consider using 20 beams for the 3 TeV design. In this case if each beam has an energy of about 1.2 GeV and a bunch spacing of 2 cm, the bunch charge is quite reasonable at 18 nC. However, it would be quite complex and expensive to create 20 separate drive beam accelerators.

An alternative can be found by considering the time and location where each drive beam is needed. Consider a layout in which the drive-beam generation complex is located at the center of the linear collider near the final focus system. Imagine the drive beams being distributed to the linac in a direction opposite to the direction of the main beam. In order for the drive beams to arrive at the appropriate time to accelerate a high energy beam travelling in the opposite direction, they should be spaced in time by twice the length of the linac section which they will power. Therefore, if we produce one drive beam with an energy of 1.2 GeV with an accelerator system that powers a length L_{sec} of the main linac, we can produce the next drive beam at a time $2L_{sec}/c$ later with the same hardware. The total length of this sequence of drive beams, consisting of 20 pulses of 120 ns duration, is twice the length of the high-energy linac. However, the current in each pulse is still very high, and it is difficult to accelerate a beam with this pulse structure and intensity. It would be much more convenient to first accelerate lower-current pulses that are longer in time, and then compress them.

4 ELECTRON BEAM COMBINATION

Electron beams are routinely combined or stacked to produce higher intensity bunches in the injection process to storage rings. In our case, we cannot use conventional stacking as this would dilute the emittance, however, if the bunches are to be used to generate RF, there is another possibility that is very useful[5].

If we use an RF deflector to inject into a ring, we can, for example, stack 4 trains of bunches longitudinally and then immediately extract them. Consider the input pulse and the process shown in Figure 1. The pulse consists of trains of bunches separated by equal spaces. If we inject into a ring with a circumference equal to the periodicity of the bunch train, then as one train of bunches comes around, they fall on top of the bunches in the next train. If the circumference is increased by $\lambda/4$, where λ is the bunch spacing, it is possible to interleave four bunch trains at the quarter points of the bunch cycle to achieve a factor of four pulse compression.

The injector region is shown in more detail in Figure 2. In this case two RF deflectors are used to create an RF bump in the combiner ring. The sequence of trajectories in the bump allows the bunches to avoid the septum during the stacking process. After injection, the high current bunch train is extracted on the opposite side

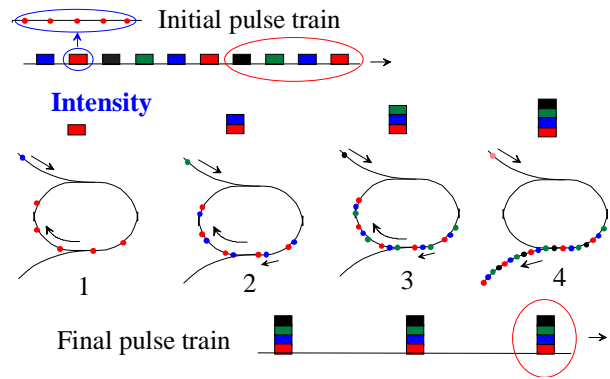

Figure 1: Times-four combination in a ring.

of the ring, and the process begins again with the next set of four bunches. This process is a kind of frequency multiplication that is not possible with RF compression.

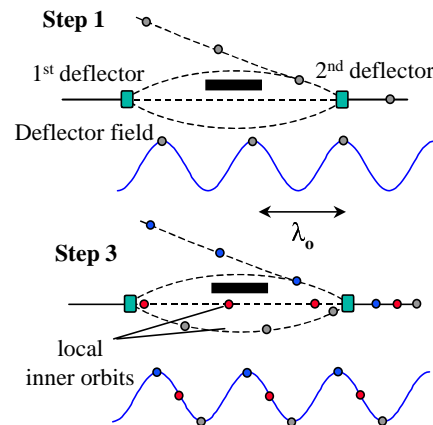

Figure 2: Injection region in the times-four combiner.

5 THE DRIVE BEAM ACCELERATOR

The process of bunch train combination described above allows the possibility of creating the high bunch train current and the gap in time between the different drive beams with a combination system consisting of rings or delay lines. Thus, one can create a continuous train of bunches with a pulse time equal to twice the linac length, then use the bunch combination described above to create higher current, higher power pulses with larger gaps between them.

This long-pulse beam can be accelerated using a conventional travelling wave linac at low frequency very efficiently. The parameters for such an accelerator are shown in Table 2. All of the energy to power one linac is stored in a continuous electron beam with a pulse time of twice the linac length, 92 μ s in the 3 TeV case.

The accelerator operates at a relatively low frequency that is related to the amount of bunch combination and frequency multiplication given by the combiner ring complex, in this case a factor of 32. The bunches each have about 18 nC of charge and are nominally on every

other cycle of the RF. Each structure is fed by two 50 MW klystrons that can be phased to provide RF amplitude tuning. Because the filling time of the structure is short (300 ns), the accelerator operates in the steady state for essentially the entire pulse.

Table 2: Drive beam accelerator parameters.

Frequency:	937 MHz
Acceleration Gradient	3.8 MV/m
Structure Length	3.1 m
Number of structures	99
Power per Structure	100 MW
Klystron Power	50 MW
Number of Klystrons	198
Beam Current	8.2 A
Final Energy	1.16 GeV
Pulse Length	92 μ s
RF to beam efficiency	97%
Energy/pulse	875 kJ
Copper Losses/meter	6.5 kW

The drive beam accelerator is run ‘fully loaded’. It is designed to run at a particular current and gradient so that essentially all of the power is transferred to the accelerated beam and almost none flows out to the load. This condition is a broad optimum and the efficiency changes little when the accelerator is slightly under or over loaded. It is straightforward to keep the beam stable in this accelerator by detuning and damping the higher-order modes of the accelerator structure.

6 OVERVIEW OF THE SYSTEM

An overview of one of the two 3 TeV RF power systems is shown in Figure 3 and is discussed in detail in [6]. It consists of an injector, a long pulse, normal conducting, fully loaded linac, a times-two delay/combiner, two combiner rings in series for pulse compression, a distribution beam line with deflector magnets, and finally a set of 20 decelerator linacs.

The first element to discuss is the times-two combiner. As discussed earlier it is very useful to have a continuous train of bunches so the drive beam accelerator can run in the steady state, fully loaded. On the other hand, we need to have a gap to allow for a kicker rise time during the extraction process in the first combiner ring. But, with a gap in the beam, there would be small transients in the beam energy that would have to be corrected. The gap could be created using a pulsed magnet, but that would result in some lost efficiency, since we would have to throw away all the charge in the gap.

The times-two combiner gives us an alternative. Imagine that we place bunches on every other RF cycle in the drive beam accelerator, and that we switch from even to odd buckets at the desired RF pulse width. In this case an RF deflector at one half the drive beam frequency can be used to separate the bunch trains on the even cycles from those on the odd cycles as shown in Figure 4. This allows us to delay one of the trains and recombine with a complimentary RF combiner so that a times-two compression is obtained with a bunch now occupying every cycle of the drive beam frequency.

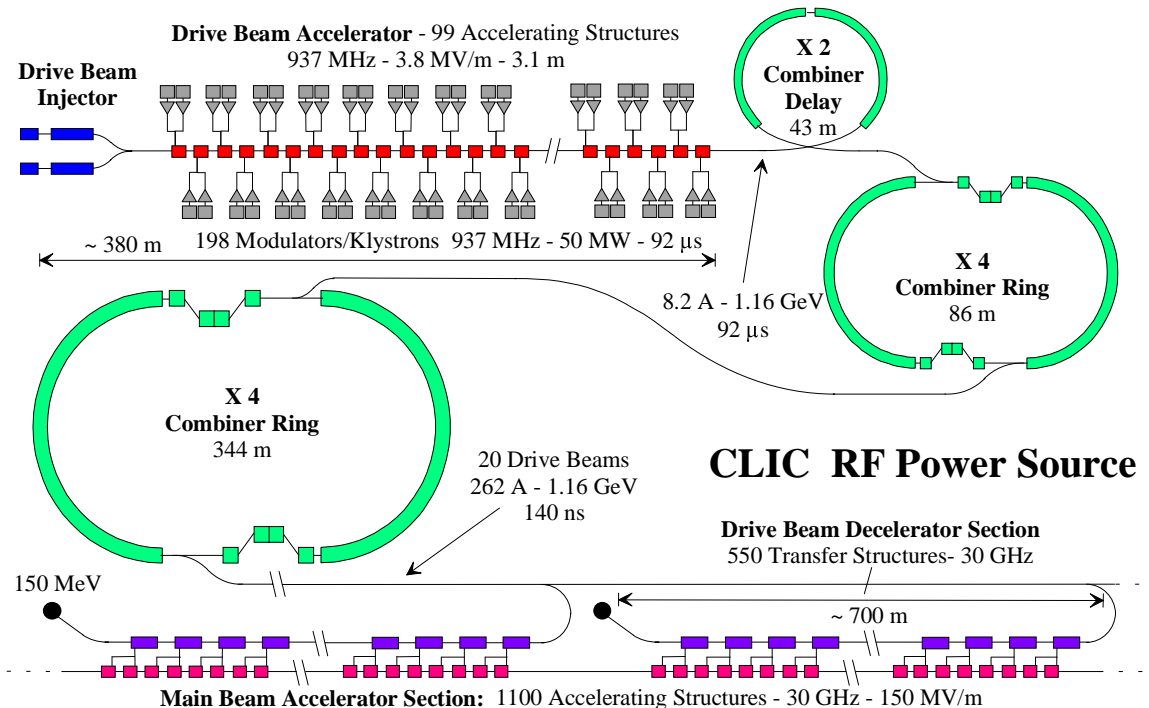

Figure 3: The 3 TeV RF Power Source.

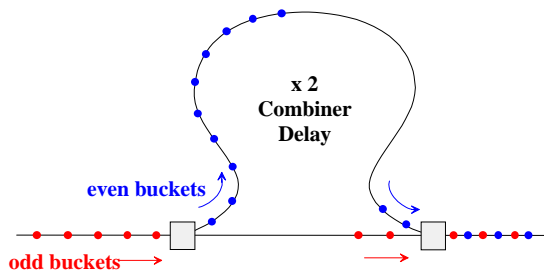

Figure 4: The first times-two combiner.

The net effect is to produce a train of pulses with gaps appropriate for the next step of the combination process.

To create the odd/even coding we can use two conventional thermionic guns as shown in Figure 5. One gun produces pulses of bunches on the even cycles while the other gun produces pulses of bunches on the odd cycles. The two trains are combined with an RF combiner, with the pulses from one side filling in the gaps from the other side to create a continuous bunch train with a constant current. A short overlap of the odd and even trains is allowed to maintain a constant current.

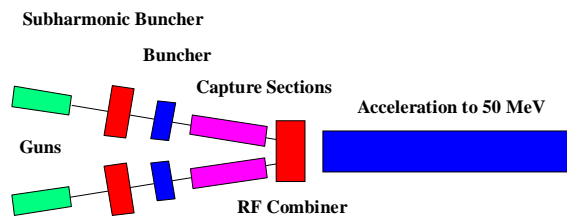

Figure 5: The drive beam injector.

The Drive Beam Accelerator described earlier accelerates the long drive beam pulse. After about 50 MeV of acceleration, the beam is collimated to clean up transverse and longitudinal phase space. The bunches in the train are compressed once at low energy to a bunch length of about 2 mm. After acceleration, the train is ready to enter the times-two combiner described earlier.

The combiner rings accomplish the energy compression, each by a factor of four, but they must be isochronous and have circumference tuning. This tuning can be accomplished with two small magnetic chicanes integrated into the ring lattice as shown above in Figure 3. After compression, the sequence of drive beam trains is transported down a common transport line. The first train is delivered to the first 700-m long section with an isochronous turn around, which has path length tuning to provide relative control of the phase in the 20 sections of the linac. The drive beam bunches are compressed to less than 500 μm just before entering the Drive Beam Decelerator. The Decelerator extracts RF power for main beam acceleration for the entire section. At the end of the Decelerator, the beam is dumped while the next drive beam is deflected into a 180-degree turn to continue the acceleration process. This process continues until the main beam reaches the end at full energy, and it is repeated each cycle of the collider.

7 DRIVE BEAM DECELERATOR

The Drive Beam Decelerator is a critical aspect of the two-beam concept. The configuration of a deceleration/acceleration module is shown in Figure 6.

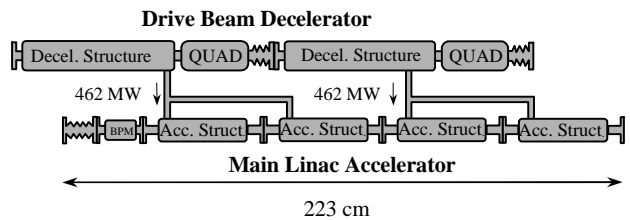

Figure 6: A module of the 3 TeV linac.

Each decelerator structure feeds two accelerator structures with RF. As the beam is being decelerated, it develops an energy spread due to the finite bunch length and due to the transient effects as the structures are filled. Since the beam is decelerated to about 10-15% of its initial energy, the total energy spread at the end of the process is around 90%. To focus such a beam, it is necessary to scale the lattice carefully to keep the lowest energy particles from being over focussed. If this is done, the entire beam is stable and confined. In the decelerator we must use an RF structure design that has the correct impedance and group velocity to provide the necessary deceleration and power output. This results in relatively low shunt impedance and a rather large group velocity. There are several possible choices of structure; but the transverse stability of the decelerating beam also requires that the structure be damped and favors lower impedance structures. A good choice is a four-channel structure, which has relatively low transverse wakefields[7]. A similar design, shown in Figure 7, is presently installed in CTF2 and has supplied up to 30 MW to a 30 GHz accelerating structure.

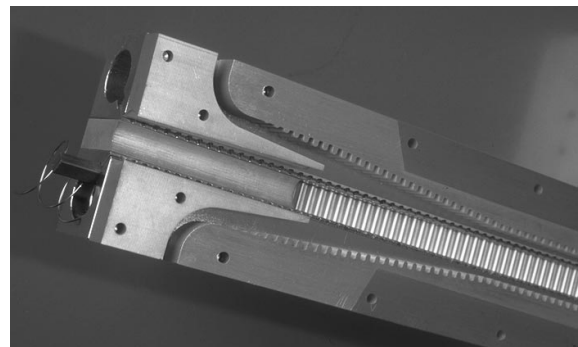

Figure 7: A four-channel decelerator structure.

Transverse stability is especially critical because of the large stored energy in a drive beam. Losses in the Decelerator could result in damage to decelerator structures. Extensive simulations have been done to check the stability in the Decelerator[8]. Provided the magnets are aligned with beam based alignment, and the beam is

steered with the average offset of the entire train, it seems possible to decelerate the drive beam to 10-15% of its initial energy. Since the beam is most sensitive at the lowest energy, it can be made more stable, if necessary, by sacrificing some efficiency. In Figure 8 you see the full beam envelope in the decelerator for a one sigma offset. Damping the decelerator structures with a Q of about 50 keeps the beam stable down to low energy.

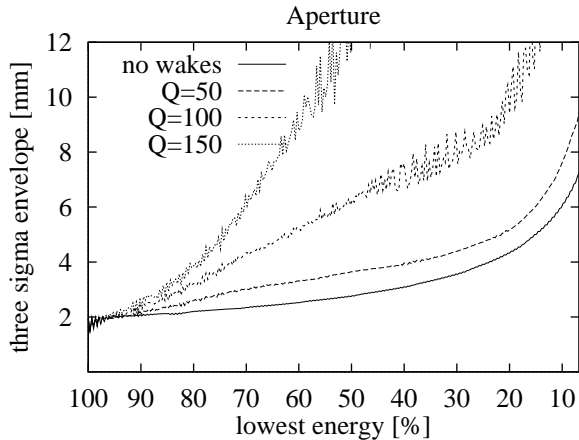

Figure 8: The beam envelope in the Decelerator with a one sigma offset for several different Q s.

8 TEST FACILITIES

In order to have confidence in any power source the method must be tested at some reasonable scale that will address key issues, for example, the use of bunch combiner rings, fully loaded acceleration and substantial drive beam deceleration. We have examined the possibility of a test facility, shown in Figure 9, that would have the key features of the design just described.

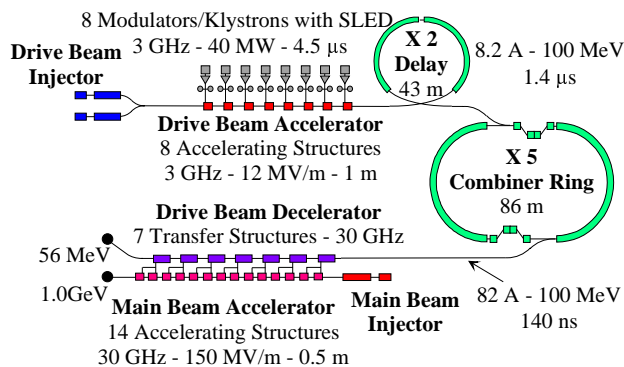

Figure 9: A Two-Beam Accelerator test facility

The facility uses existing klystrons and modulators at 3 GHz to accelerate a drive beam. The system then has a times-ten pulse compression system, using one times-two combiner delay and one times-five ring. The drive beam can then be decelerated to low energy to provide up

to 1 GeV of energy to a test beam accelerated at 30 GHz with the nominal gradient and pulse length.

9 CONCLUDING REMARKS

The entire RF system described here acts like a transformer of the acceleration gradient and frequency in the drive beam accelerator to the main beam accelerator. The transformer ratio is about 40 for the gradient and 32 for the frequency. In order to increase the gradient in the main linac, first we increase the gradient in the drive beam accelerator, and then increase the current so that it is once again fully loaded. This higher energy beam can be transported and compressed with scaled magnetic settings. In the drive beam decelerator, the beam provides more power due to the higher current so the main linac gradient increases proportionally to that in the drive beam accelerator. The amount of deceleration of the drive beam also scales so that the higher energy drive beam still powers the same length of linac.

A list of efficiencies for the design discussed here is shown in Table 3. It is too early to know precisely the efficiencies of all of the subsystems; however, this type of drive beam system should have an efficiency comparable to the RF systems contemplated for other designs.

Table 3: AC to RF efficiency

Item	Assumed	Target
Modulator	90%	92%
Klystron	65%	70%
Drive Beam Acc.	92%	94%
Decelerator	69%	80%
Power extraction	95%	97%
Power Transfer	95%	97%
Overall	34%	46%

To conclude, it is important to note that this type of two-beam design is applicable to linear colliders using any frequency of acceleration. In particular, the drive beam complex is rather insensitive to this choice and depends more on the necessary energy stored per pulse and the repetition rate. It is even possible to use essentially the same drive beam for different but harmonically related frequencies.

REFERENCES

- [1] A.M. Sessler, AIP Conf. Proc. 91 (1982) 154.
- [2] W. Schnell, CERN-LEP-RF/86-06.
- [3] J. -P. Delahaye, this conference, CERN/PS 98-009.
- [4] G. Carron, A. Millich, L. Thorndahl, CLIC Note 352 (1998).
- [5] R. Corsini and J. -P. Delahaye, CERN/PS 98-008.
- [6] 'A New Kind of Two Beam Accelerator', the CLIC Study Group, CERN/PS 98-011 and CLIC Note 364.
- [7] A. Millich and L. Thorndahl, CERN/PS 98-012.
- [8] A. Riche and D. Schulte, CERN/PS 98-013.