

# THE SWISS FEL RF GUN: RF DESIGN AND THERMAL ANALYSIS

J.-Y. Raguin, M. Bopp, A. Citterio, A. Scherer  
 PSI, CH-5232 Villigen, Switzerland

## Abstract

We report here on the design of a dual-feed S-band 2.5-cell RF gun, developed in the framework of SwissFEL, capable of operating at 100 Hz repetition rate. As in the LCLS RF gun, z-coupling, to reduce the pulsed surface heating, and a racetrack coupling cell shape, to minimize the quadrupolar component of the fields, have been adopted. The cell lengths and the iris thicknesses are as in the PHIN gun operating at CERN. However the iris aperture has been enlarged to obtain a frequency separation between the operating  $\pi$  mode and the  $\pi/2$  mode higher than 15 MHz. An amplitude modulation scheme of the RF power, which allows one to obtain a flat plateau of 150 ns for multibunch operation and a reduced average power is presented as well. With an RF pulse duration of 1  $\mu$ s it is shown that operation at 100 MV/m and 100 Hz repetition rate is feasible with very reasonable thermal stresses.

## INTRODUCTION

Paul Scherrer Institut is completing the study of the accelerating systems of SwissFEL, a Free Electron Laser which targets a maximum electron beam energy of 5.8 GeV. SwissFEL is designed for two standard electron beam operation modes, one with a 200 pC charge per bunch and a core slice emittance of 0.43 mm-mrad and the second with a 10 pC charge per bunch and a core slice emittance of 0.18 mm-mrad. SwissFEL, the main linac frequency being the C-band American frequency 5712 MHz, operates with a repetition rate of 100 Hz and two electron bunches, with a spacing of 28 ns, are accelerated at each RF pulse.

The proposed 2.5-cell RF gun operates with a nominal body temperature of 40 °C in the  $\pi$  mode at the S-band frequency of 2998.8 MHz, such a frequency having a common sub-harmonic with the SwissFEL C-band main linac frequency. The beam energy at the exit of the RF gun is about 7 MeV. The two full cell lengths and the iris thicknesses of the RF gun are identical to the ones of the CTF3 PHIN RF gun [1]. The upstream cell, shorter than the two full cells, has a longitudinally adjustable backplane. The middle cell is coupled to two rectangular waveguides symmetrically arranged to cancel the dipolar component of the field. The racetrack interior shape of this coupling cell is optimized to minimize the quadrupolar field component, as in the LCLS RF gun [2]. Long lifetime and reliable operation with the targeted peak on-axis electric field of 100 MV/m requires the optimization of the two RF coupling port dimensions to reduce the dynamic thermal stress due to pulsed heating. With the high 100 Hz repetition rate, mechanical stresses caused by thermal loading have to be thoroughly addressed.

## SWISSFEL RF GUN DESIGN

### Design with 2D RF Simulations

Ignoring at this stage the middle cell coupling ports, RF simulations performed with the 2D electromagnetic code SUPERFISH [3] are used to determine the radius and the elliptical shape of the irises between the cells compatible with reduced surface electric fields and large frequency separation between the operating  $\pi$  mode ( $TM_{010-\pi}$  mode) and the  $\pi/2$  next lower mode ( $TM_{010-\pi/2}$  mode). The radius of the upstream cell and of the two full cells are adjusted to reach a balanced on-axis field at the operating frequency. The 2D RF design was then guided by the requirements that the mode separation between the operating  $\pi$  mode and the  $\pi/2$  mode be higher than 15 MHz and that the peak surface electric field is not higher than the electric field on the cathode. The large mode separation between the operating mode and the next lower mode reduces the impact of the lower mode on the electron bunch energy spread and projected emittance. It is also expected to make the field balance less sensitive to thermal expansion under operational conditions and to manufacturing dimension deviations that may occur during production [4].

Fig. 1 shows the electric field contour lines of the  $\pi$  mode. The cell radii are optimized to obtain field flatness at the operating frequency. The dimensions of some geometrical parameters, used also for the final 3D design, are specified in Table 1. The elliptical profile of the irises is characterized by an aspect ratio of 1.7:1 so that the maximum surface electric field is lower than the peak field on the cathode.

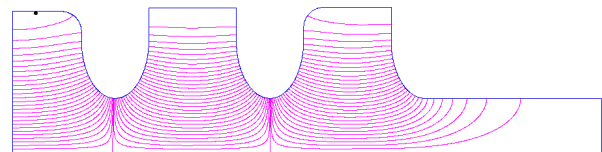

Figure 1: Electric field contour lines of the operating  $\pi$  mode

Table 1: Geometrical parameters of the SwissFEL RF gun

| Parameter      | Value   |       |       |
|----------------|---------|-------|-------|
| Cell length    | 20.5 mm | 26 mm | 26 mm |
| Iris thickness | 20 mm   |       |       |
| Iris radius    | 16 mm   |       |       |
| Drift radius   | 16 mm   |       |       |

### Final Design with 3D RF Simulations

The dimensions obtained with the 2D code SUPERFISH are used as input to complete the RF design of the gun with the 3D electromagnetic code HFSS [5], in particular the

design of the two RF coupling ports and of the racetrack shaped coupling cell [2, 6]. The coupling apertures, located in the middle cell, are optimized to minimize field distortion, to obtain a coupling coefficient  $\beta$  around 2 and to ensure that the temperature rise per pulse of the most exposed areas does not exceed  $50^\circ\text{C}$ . To fulfill these three criteria, the two main features that have been adopted are coupling apertures running longitudinally all along the coupling cell, i.e. z-coupling scheme, and a large inner edge radius of the apertures. In addition, a balanced on-axis electric field is obtained with a minor change of the upstream and downstream cell radii. A cross-section of the RF gun is shown in Fig. 2.

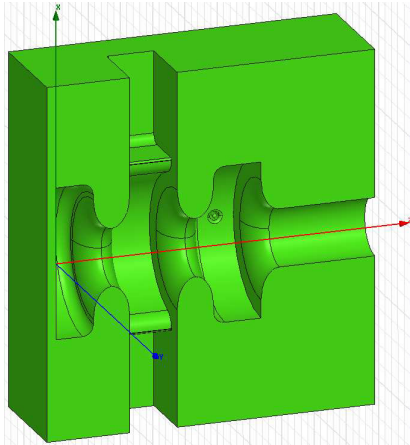

Figure 2: Cross-section of the SwissFEL RF gun.

Fig 3 shows the on-axis electric field along the RF gun in the final RF design. The ratios of the three maxima of the on-axis electric fields are higher than 98%.

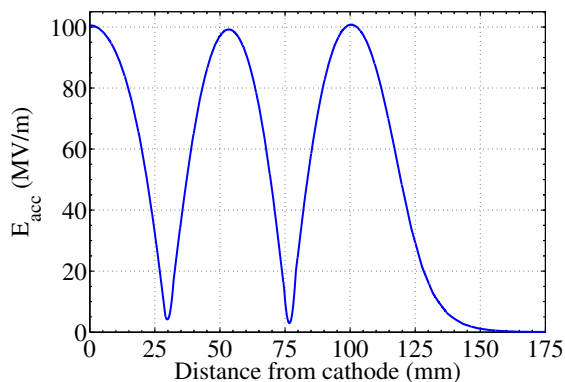

Figure 3: On-axis electric field of the SwissFEL RF gun.

The coupling apertures induce field distortion in the vicinity of the gun axis that may deteriorate the electron bunch quality. The two symmetrically arranged apertures allow one to cancel the dipolar component of the fields. To reduce the quadrupolar fields, the coupling cell has a racetrack transverse profile. For a given inner edge radius of the apertures, there is some specific combination of aperture width and length of the racetrack straight section which minimizes the quadrupolar component. Fig 4 shows the amplitude of the longitudinal electric fields along both transverse directions of the coupling cell middle plane (see

ISBN 978-3-95450-122-9

Fig 2 for the definition of the x- and y-axis). Such equal amplitudes are obtained for a width and an inner radius of the coupling apertures of 17.73 mm and 8.5 mm, respectively whereas the racetrack straight section is 7.1 mm long.

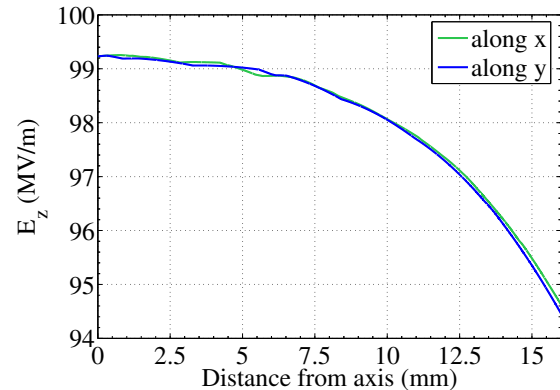

Figure 4: Amplitude of the longitudinal electric field along transverse directions of the SwissFEL RF gun.

The design coupling coefficient  $\beta$  has been chosen to be 2. Overcoupling the cavity at the operating frequency decreases the filling time of the RF gun. The nominal accelerating field can then be reached with a shorter RF pulse, a requirement for reducing the mechanical stresses on the gun body due to thermal loading. In the final design, the  $\pi$ -mode resonance frequency is within 100 kHz of the design frequency with a calculated coupling coefficient  $\beta$  of 1.98. The  $\pi/2$  mode is about 16 MHz lower in frequency and the coupling coefficient  $\beta$  is 0.2.

An upper bound of the temperature rise per pulse on the inner surface of the RF gun can be analytically estimated by assuming a constant amplitude of the surface magnetic field over the whole pulse length. This limit  $(\Delta T)_{max}$  is given by the formula:  $(\Delta T)_{max} = (R_s/K) \sqrt{D/\pi} \sqrt{t_{pulse}} |H_s|^2$ , where  $R_s$ ,  $K$  and  $D$  are the surface resistance, the thermal conductivity and the specific heat of copper, respectively, at the operating frequency, whereas  $t_{pulse}$  and  $|H_s|$  are the pulse length and the amplitude of the surface magnetic field, respectively. The distribution of the temperature rise for a  $3 \mu\text{s}$  pulse on the surface of one of the coupling apertures is shown on Fig 5. The amplitude of the surface magnetic field corresponds to a peak on-axis electric field of 100 MV/m. The maximum temperature rise, located all along the aperture, is lower than  $45^\circ\text{C}$ .

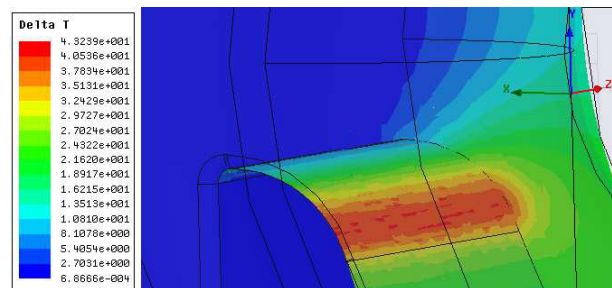

Figure 5: Coupling aperture temperature rise for a  $3 \mu\text{s}$  RF pulse and a peak on-axis field of 100 MV/m.

## TRANSIENTS AND THERMAL STRESSES

Since SwissFEL is planned for a two-bunch operation with a 28 ns spacing, an amplitude modulation scheme of the RF input power is proposed to maintain a constant amplitude of the peak accelerating field for a duration longer than the bunch spacing. Assuming zero rise and fall times, an RF power of about 14 MW is required to reach the 100 MV/m nominal peak accelerating field with a 3  $\mu$ s rectangular RF pulse. In the amplitude modulation scheme, assuming a 1  $\mu$ s total RF pulse and targeting the nominal peak accelerating field, an RF power of about 18 MW during the first 850 ns of the RF pulse feeds the cavity. The RF power is then quickly reduced to about 14 MW and is kept constant during the last 150 ns of the RF pulse. Such a scheme results in a flat-topped accelerating field of 100 MV/m (see Fig 6). The reflected power is maximum at the end of the RF pulse and is about 28 MW.

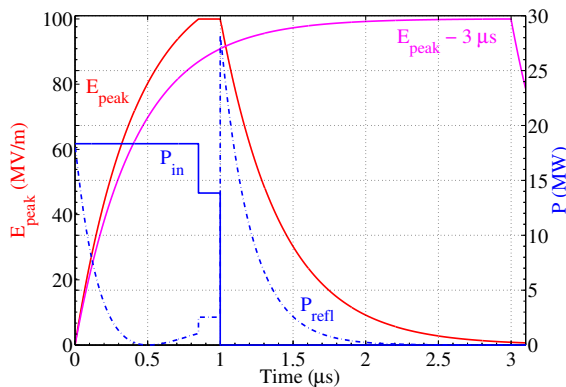

Figure 6: Transient-states of the peak accelerating field and of the RF input and reflected powers.

With this amplitude modulation scheme and with a repetition rate of 100 Hz, the average dissipated power is as low as 0.9 kW (see Fig 7). The temperature rise per pulse on the coupling apertures due to pulsed heating, estimated more rigorously by taking into account the transient behavior of the magnetic surface field during the whole pulse duration [7], is reduced to about 18 °C. With a 3  $\mu$ s rectangular RF pulse, the average dissipated power is about three times higher and the temperature rise is about twice higher.

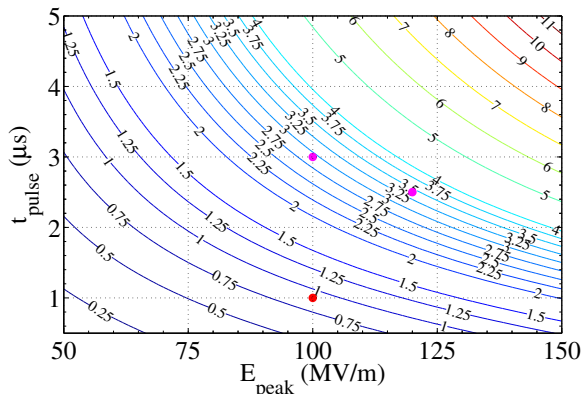

Figure 7: Average dissipated power (kW) vs. peak accelerating field and pulse length for a repetition rate of 100 Hz.

The number, size and location of the cooling channels in the RF gun body are determined with ANSYS [5] simulations for operation with an inlet water temperature of 40 °C and a maximum average dissipated power of 3.5 kW. The thermally induced stresses in the gun body are within an acceptable range with a 0.9 kW thermal load (see Fig 8).

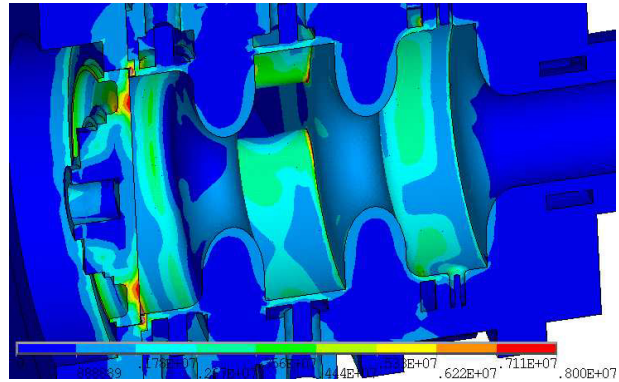

Figure 8: Thermal stress (N/m<sup>2</sup>) for a 0.9 kW average load on the SwissFEL RF gun body.

## CONCLUSIONS

A dual-feed S-band 2.5-cell RF gun operating in the  $\pi$  mode has been designed for SwissFEL which allows a two-bunch operation with an amplitude modulation scheme of the RF input power. A peak on-axis accelerating field of 100 MV/m can be maintained constant for 150 ns within a 1  $\mu$ s total RF pulse length. For a pulse repetition frequency of 100 Hz, the total average power loss is then less than 1 kW and the temperature rise per pulse is well below the critical limit. Thermo-mechanical studies led to a design such that the RF gun can safely operate with a thermal load lower than 3.5 kW. The RF gun can then also operate safely at 120 MV/m in the single- and two-bunch regimes. However, the RF pulse length shall not exceed 2.5  $\mu$ s when operating without amplitude modulation of the input power.

## REFERENCES

- [1] R. Roux, “Conception of Photoinjectors for the CTF3 Experiment”, *Int. J. Mod. Phys. A* 22 (2007), pp. 3925-3941.
- [2] L. Xiao et al., “Dual Feed RF Gun Design for the LCLS”, *Proc. PAC 2005*, pp. 3432-3434, Knoxville, 2005, <http://www.JACoW.org>.
- [3] J. H. Billen and L. M. Young, “Poisson / Superfish”, Los Alamos National Laboratory, LA-UR-96-1834, 1996.
- [4] D. H. Dowell et al., “The Development of the Linac Coherent Light Source RF Gun”, *ICFA Beam Dynamics Newsletter* No. 46 (2008), pp. 162-192.
- [5] <http://www.ansys.com>
- [6] J. Haimson et al., “A Racetrack Geometry to Avoid Undesirable Azimuthal Variations of the Electric Field Gradient in High Power Coupling Cavities for TW Structures”, *Proc. 7th Workshop on Advanced Accelerator Concepts, Lake Tahoe, 1996*, AIP Conf. Proc. 398, pp. 898-911.
- [7] D. P. Pritzkau et al., “Experimental Study of RF Pulsed Heating on Oxygen Free Electronic Copper”, *Phys. Rev. ST Accel. Beams* 5, 112002 (2002).