

STATUS OF THE CLIC/CTF BEAM INSTRUMENTATION R&D

M. Wendt^{*}, A. Benot-Morell, B. P. Bielawski, L. Bobb, E. Bravin, T. Lefevre, F. Locci, S. Magnoni, S. Mazzoni, E. Nebot del Busto[#], R. Pan, J. Towler, CERN, Geneva, Switzerland
 W.A. Gillespie, D.A. Walsh, University of Dundee, Dundee, UK
 S.P. Jamison, STFC Daresbury Laboratory, Daresbury, UK
 T. Aumeyr, S. Boogert, P. Karataev, A. Lyapin, J. Snuverink,
 James Adams Institute at Royal Holloway, University of London, Egham, UK
 J.M. Nappa, S. Vilalte, LAPP, Annecy, France

Abstract

The Compact Linear Collider (CLIC) is an e^+e^- collider based on the two-beam acceleration principle, proposed to support precision high-energy physics experiments in the energy range 0.5-3 TeV [1]. To achieve a high luminosity of up to $6 \times 10^{34} \text{ cm}^{-2} \text{ s}^{-1}$, the transport and preservation of a low emittance beam is mandatory. A large number and great variety of beam diagnostics instruments is foreseen to verify and guarantee the required beam quality.

We discuss the status of the beam diagnostics developments and experimental results accomplished at the CLIC Test Facility (CTF) and at the Cornell University CsrTA ring accelerator.

INTRODUCTION

The CLIC Test Facility (CTF) is an R&D facility to demonstrate the feasibility of the CLIC two-beam acceleration concept, and used to test mission critical components under realistic beam conditions, including novel beam diagnostics and instrumentation systems [2]. While most beam diagnostics can be tested at CTF, e.g. beam position monitors (BPM), beam loss monitors (BLM), longitudinal beam diagnostics and most other beam instrumentation, the study of non-invasive transverse beam diagnostics based on optical diffraction radiation requires higher beam energies than 200 MeV, so this development was achieved in collaboration with Cornell University at the CsrTA ring accelerator [3].

BEAM POSITION MONITORS (BPM)

Main Beam Cavity BPM R&D

A prototype cavity BPM made out of stainless steel is currently installed at the end of the CTF *Califes* probe beam. The charge and position sensitivity of the pickup have been studied and reported on previously [4]. Recently, translation stages were installed, allowing better control of the beam position within the BPM. The sensitivity measurements were repeated using these movers. Table 1 shows a comparison of the previously measured sensitivities and those measured using the translation stages. The vertical measurements differ to some degree, mostly because of the large beam jitter,

causing beam losses along the *Califes* beam-line. These instabilities are present during charge scans, meaning the charge measured at the gun does not correspond to that seen in the BPM. Therefore, a more careful scan is foreseen, ensuring no beam losses along the passage. Despite this issue, the movers have helped yield promising results, as calibration scale factors of horizontal and vertical positions came out to be almost identical. Two calibration scans are shown in Fig. 1.

Table 1: Comparison of Measured Sensitivities before and after the Installation of Translation Stages

Sensitivity Meas.	Previous Run	Current Run
X Pos. [V/mm/nC]	16.6 ± 0.2	16.7 ± 0.5
Y Pos. [V/mm/nC]	15.9 ± 0.4	18.8 ± 0.6
Intensity [V/nC]	608 ± 2	628 ± 2

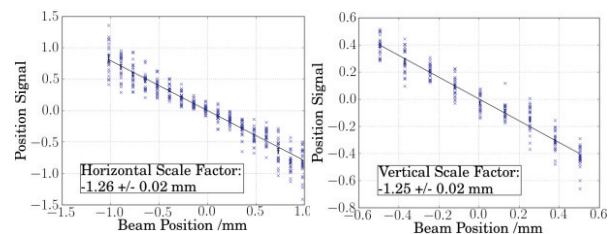

Figure 1: Example of beam position calibration.

A redesigned prototype made out of copper, giving it higher Q factor, and therefore a better signal-to-noise ratio is currently being manufactured [5]. It also incorporates an improved waveguide-to-coaxial coupler, designed to eliminate the tuners used on the current prototype. Furthermore a new RF front-end down-converter is under development, with first prototype tests foreseen for autumn. A comprehensive beam study with three of these Cu cavity BPMs installed at CTF3-*Califes* is planned for 2015, to achieve the ultimate goal of demonstrating the combined 50 nm spatial and 50 ns temporal resolution, as required for CLIC.

Drive Beam Stripline BPM R&D

Following the successful beam studies of the first stripline BPM prototype [6], its electronic acquisition system has been integrated into the control and timing system of CTF3, allowing synchronization of shot-by-shot data. New beam studies have been performed to verify the performance in the presence of 12 GHz RF signals from the Power Extraction and Transfer Structures (PETS). For two different PETS power settings, 2.4 MW

[#] and University of Liverpool, Liverpool, UK

^{*} manfred.wendt@cern.ch

and 27 MW, the BPM linearity measured by scanning a vertical corrector magnet turned out to be very similar, showing only a small increase in the electrical offset (EOS) for the high power setting (Fig. 2). The data also indicates a tilt between quadrupole QDR0800 and our BPM, of approximately 5 mrad for the horizontal, and 9 mrad for the vertical plane.

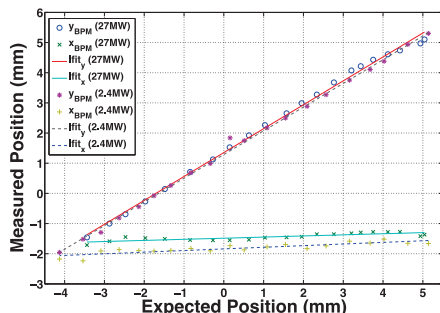

Figure 2: Measured vs. expected beam position in the vertical plane for PETS RF power values of 2.4 MW (dashed lines) and 27 MW (solid lines).

To improve the suppression of 12 GHz RF components, a stripline BPM with effective notch-filtering properties is under development. A ring of SiC is placed at each end of the striplines to damp a strong resonance peak of the transverse wake impedance observed in EM simulations. The physical length of the stripline was corrected to compensate the electrical lengthening effect of the damping material, while the reduction of the electrode angular coverage (20° vs. 45°) ensures a TEM-like field propagation, reducing spurious resonances [7]. These modifications are expected to provide a substantial notch effect at 12 GHz (Fig. 3), which should improve the suppression of high power RF EMI from the PETS.

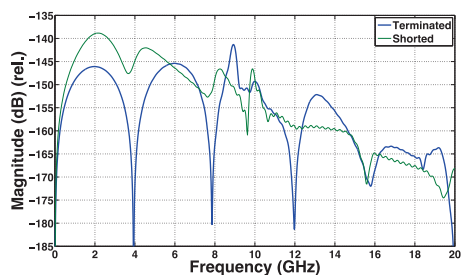

Figure 3: Frequency response of CLIC Drive Beam stripline BPM prototypes with shorted (green) and terminated (blue) electrodes.

Read-out and DAQ Electronics

The acquisition system (see Figure 4) is mainly composed of two parts. The front-end electronics, installed in the accelerator tunnel and shielded against radiation by a concrete wall, digitalizes the signals from each BPM electrodes using a software-based self-trigger. The data are then transferred via optical fibers towards a digital acquisition system housed in a μ TCA crate, which is located in the radiation free area. Three consecutive layers of software allow controlling the electronics and displaying the data in the control room. A CORBA-based

middleware allows data exchange with the low-level control software. The latter based on CERN FESA (Front End Software Architecture) framework is responsible for gathering the data from the DAQ whenever a beam pulse is delivered, using UDP/IP reading and writing to a dedicated shared memory.

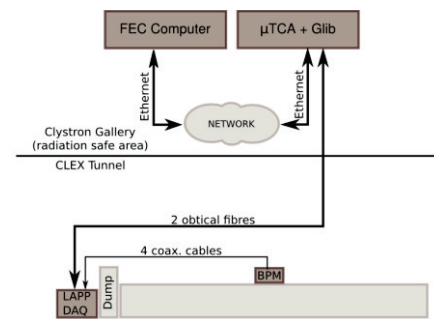

Figure 4: CTF signal processing and DAQ scheme.

BEAM LOSS MONITOR (BLM) R&D

The use of optical fibers as beam loss monitors (BLM) is being investigated for the CLIC Two Beam Module as a cost effective technology [8]. Readout electronics and photo sensors are under study to reach the maximum performance in sensitivity and time resolution. The responses of pin diodes and silicon photo multipliers (SiPM) have been tested using 70 ps light pulses. In Fig. 5, the integrated signals for both detectors are shown versus the repetition rate of the test laser pulse. The drop for repetition rates below 1μ s is due to the bandwidth of the $5 \text{ k}\Omega$ transimpedance amplifier used for the SiPM readout.

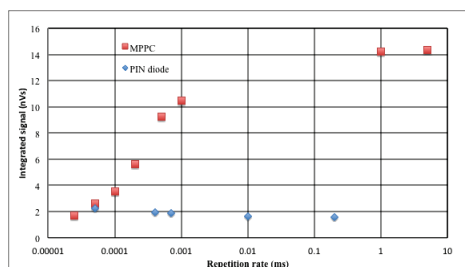

Figure 5: Integrated signals for SiPM and pin diode vs repetition rate.

As expected, the sensitivity of SiPMs is significantly better than that of a pin diode since these devices can detect single photons. This was confirmed while measuring beam-induced light, as presented in Figure 6. The signals were recorded simultaneously with a multi-pixels photon counter (MPPC), a pin diode connected to a broadband (200 MHz) preamplifier, and a fast (0.5 ns FWHM) PMT connected to the downstream, upstream and upstream background light extraction lines of the optical fibers located at the TBL [1]. The signal from the MPPC reaches saturation of the readout amplifier for values of -20 mV while the pin diode (amplified by a factor 100 in the graphic) does not provide any significant signals. The PMT is sensitive enough to observe the light pulse, and has enough resolution to allow the observation of internal structure of losses within the bunch train.

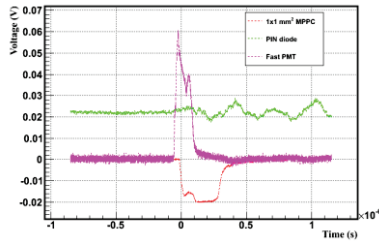

Figure 6: Signals observed with the optical fiber, located along the test beam line couples to a SiPM module, a pin diode and a fast photo multiplier.

LONGITUDINAL BEAM DIAGNOSTICS

Non-invasive, high-energy scalable, electro-optic (EO) longitudinal profile diagnostics are being developed for CLIC, targeting improvements in resolution to 20 fs RMS and in reliability [1,9,10]. A low resolution (~1 ps) EO spectral decoding system has been commissioned on the CTF *Califes* beamline for the investigation of reliability, noise, and novel deconvolution processes. The system employs a commercial frequency doubled erbium fibre laser producing 110 fs FWHM, 780 nm, 3.5 nJ, probe pulses at 37.5 MHz. The probe can be chirped to any length within 6.6-16.3 ps to optimise resolution/noise, and is then free-space transported to the *Califes* beamline. Here the Coulomb field profile is spectrally encoded onto the laser probe, which is locally coupled into a fibre optic for transport to a bespoke spectrometer. An example spectral decoding measurement is shown in Fig. 7. The signal-noise obtained is in line with design expectations.

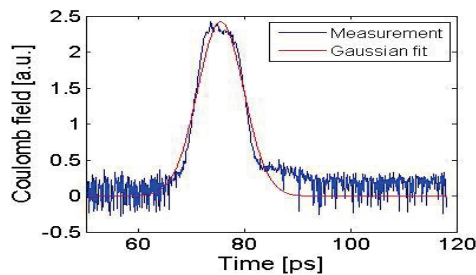

Figure 7: A 10.3 ps FWHM, 700 pC, bunch measured at the CTF *Califes* beamline by EOSD techniques.

A previously unrecognised alignment effect in the EO process has also been identified; under normal conditions, where the optical probe and electron trajectory are near, but not precisely, parallel, the EO signal acquires an angular chirp. Combined with the angular acceptance of the detection system this can significantly distort measurements, see Fig. 8. This is comprehensively reported in [11].

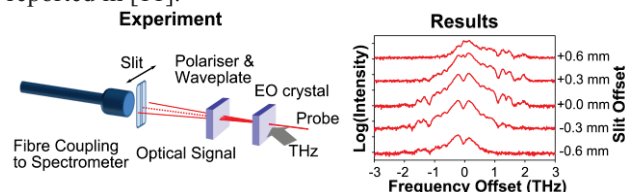

Figure 8: Alignment dependent distortions in EO up-conversion signal measured through aperture offsets [11].

TRANSVERSE BEAM DIAGNOSTICS

In April 2014, diffraction radiation (DR) at 600 nm was observed from 1 and 0.5 mm target apertures using 2.1 GeV electrons in the CESR ring. The optical system allows for direct imaging of the target surface (used for beam alignment in the slit) and observation of the DR angular distribution (required for vertical beam size measurement). The targets are equipped with a slit and an upstream mask, the latter being used to block background synchrotron radiation. The mask has a stepped design with apertures 2 and 4 times larger than the slit in order to run in a regime with and without interferences from forward DR emitted by the mask as shown in Figures 9.



Figure 9: Target images using 0.5 mm target aperture and 2 mm (left), and 1 mm mask aperture (right).

An example of the angular distribution obtained in the interference case is shown in Figures 10. A preliminary analysis shows that the visibility of interference fringes varies as a function of the beam size, as predicted by theory [12]. A detailed analysis is on-going.

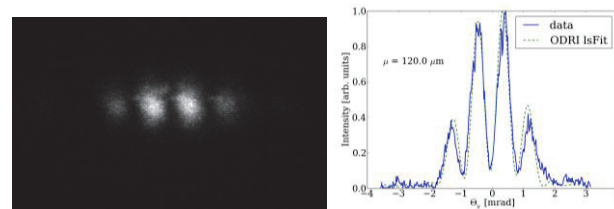

Figure 10: Image of DR angular distribution with mask/target interference case (left), and a least squares fit of the central angular distribution line profile giving 17.6 μm beam size, 4.08 μrad beam divergence and 0.12 mm beam offset w.r.t. the centre of the target aperture (right).

REFERENCES

- [1] “CLIC Conceptual Design Report (CDR)”, Geneva, (2012).
- [2] G. Geschonke, et al. (The CLIC Study Team), “CTF3 Design Report”, No. CERN/PS-2002-008, (2002).
- [3] D. Rubin et al., “CesrTA Layout and Optics”, PAC2009, Vancouver, Canada, WE6PFP103, p. 2751.
- [4] F. J. Cullian, “First Beam Tests of a Prototype Beam Position Monitor for the CLIC Main Beam”, TUPC19, IBIC2013, Oxford, UK, (2013).
- [5] J. R. Towler, “Technologies and R&D for a High Resolution Cavity BPM for the CLIC Main Beam”, TUPC20, IBIC2013, Oxford, UK, (2013).

- [6] A. Benot-Morell, et al., “Status of the Stripline Beam Position Monitor Development for the CLIC Drive Beam”, TUPC12, IBIC2013, Oxford, UK, (2013).
- [7] A. Benot-Morell, et al., “Design and Characterization of a Prototype Stripline Beam Position Monitor for the CLIC Drive Beam”, MOPA16, IBIC2012, Tsukuba, Japan, (2012)
- [8] L. Devlin, et al. “Update on Beam Loss Monitoring at CTF3 for CLIC”. Proceedings IBIC 2013.
- [9] P.N. Burrows, et al., “Status of the CLIC-UK R&D Programme on Design of Key Systems for the Compact Linear Collider”, TUPME008, IPAC 2014, Dresden, Germany, (2014).
- [10] D.A. Walsh, et al, “A femtosecond resolution electro-optic diagnostic using a nanosecond-pulse laser”, Proceedings of IBIC 2013, Oxford, UK, ISBN 978-3-95450-127-4, pp474-477.
- [11] D. A. Walsh, et al., “Role of misalignment-induced angular chirp in the electro-optic detection of THz waves.” Optics Express, 22, 12028-12037, (2014).
- [12] A. Cianchi, M. Castellano, L. Catani, et al., Physical Review ST-AB 14, 102803, (2011).