

DUAL AC DIPOLE EXCITATION FOR THE MEASUREMENT OF MAGNETIC MULTIPOLE STRENGTH FROM BEAM POSITION MONITOR DATA*

M. Spata[#], G. A. Krafft

Thomas Jefferson National Accelerator Facility, Newport News, VA 23606, USA.

Abstract

An experiment was conducted at Jefferson Lab's Continuous Electron Beam Accelerator Facility to develop a technique for characterizing the nonlinear fields of the beam transport system. Two air-core dipole magnets were simultaneously driven at two different frequencies to provide a time-dependent transverse modulation of the electron beam. Fourier decomposition of beam position monitor data was then used to measure the amplitude of these frequencies at different positions along the beamline. For a purely linear transport system one expects to find solely the frequencies that were applied to the dipoles with amplitudes that depend on the phase advance of the lattice. In the presence of nonlinear fields one expects to also find harmonics of the driving frequencies that depend on the order of the nonlinearity. The technique was calibrated using one of the sextupole magnets in a CEBAF beamline and then applied to a dipole to measure the sextupole strength of the magnet. A comparison is made between beam-based measurements, results from Elegant [1] simulations and data from our Magnet Measurement Facility.

INTRODUCTION

The CEBAF accelerator is a 5-pass 6 GeV polarized CW electron machine that is presently being upgraded to 12 GeV (Fig.1) [2].

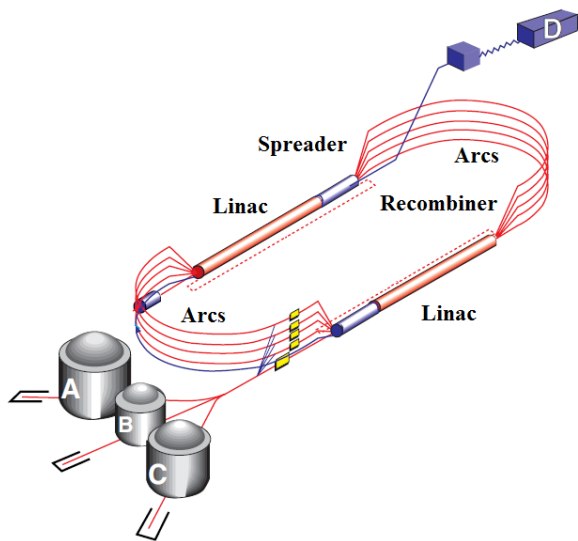

Figure 1: Schematic of the CEBAF 12 GeV upgrade.

The Arc, Spreader and Recombiner magnets of the machine will require upgraded power supplies and additional steel to transport the higher energy beam within the existing racetrack layout. Field quality of the individual magnets and the systems of magnets that comprise the Spreader and Recombiner segments will need to be well characterized to enable us to deliver high quality beam to our users. Beam-based techniques are being developed to supplement offline modelling and magnet measurement data to be used as the new beamlines are commissioned. Dual AC dipole excitation to search for nonlinear components of beamline elements is one of those tools.

Model

A simple model of zero-length elements can be used to show how two different AC dipole frequencies will propagate and mix across a nonlinear lattice and be detected in a beam position monitor (Fig.2).

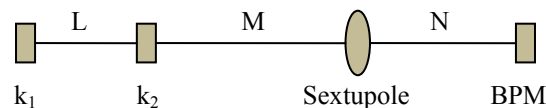

Figure 2: Model for evaluating nonlinear transport.

We use transfer matrices to represent the beamline between the elements of the model. The segment between the two AC dipoles k_1 and k_2 is represented by the matrix L , the segment between the second AC dipole and the sextupole is represented by matrix M and the last segment from the sextupole to the beam position monitor is represented by matrix N .

The beam position and angle entering any element will be noted with a minus sign while the angle and position leaving a beamline element will be noted with a plus sign in the subscript. Pure modulations in the x-plane will be assumed for the development of this model.

For the beam entering k_1 the initial conditions for position and angle are set as

$$X_{k1-} = X'_{k1-} = 0. \tag{1}$$

We apply an AC modulation with amplitude A_1 and frequency ω_1 to the first kicker. The position and angle at the exit of k_1 are

$$X_{k1+} = 0 \tag{2}$$

$$X'_{k1+} = A_1 \cos \omega_1 t. \tag{3}$$

* Authored by Jefferson Science Associates, LLC under U.S. DOE Contract No. DE-AC05-06OR23177
[#]spata@jlab.org

We use the L transfer matrix to take the beam from the exit of the first kicker to the entrance of the second kicker.

$$\begin{pmatrix} X_{k2-} \\ X'_{k2-} \end{pmatrix} = \begin{pmatrix} L_{11} & L_{12} \\ L_{21} & L_{22} \end{pmatrix} \begin{pmatrix} X_{k1+} \\ X'_{k1+} \end{pmatrix} \quad (4)$$

$$X_{k2-} = L_{12} A_1 \cos \omega_1 t \quad (5)$$

$$X'_{k2-} = L_{22} A_1 \cos \omega_1 t. \quad (6)$$

We apply an AC modulation to the second kicker with amplitude A_2 and frequency ω_2 . The position at the exit of k_2 remains unchanged but the angle is modified.

$$X_{k2+} = L_{12} A_1 \cos \omega_1 t \quad (7)$$

$$X'_{k2+} = L_{22} A_1 \cos \omega_1 t + A_2 \cos \omega_2 t \quad (8)$$

Using the M transfer matrix to take the beam from the exit of the second kicker to the entrance of the sextupole we have

$$\begin{pmatrix} X_{s-} \\ X'_{s-} \end{pmatrix} = \begin{pmatrix} M_{11} & M_{12} \\ M_{21} & M_{22} \end{pmatrix} \begin{pmatrix} X_{k2+} \\ X'_{k2+} \end{pmatrix} \quad (9)$$

$$X_{s-} = (ML)_{12} A_1 \cos \omega_1 t + M_{12} A_2 \cos \omega_2 t \quad (10)$$

$$X'_{s-} = (ML)_{22} A_1 \cos \omega_1 t + M_{22} A_2 \cos \omega_2 t. \quad (11)$$

The sextupole is a nonlinear element with magnetic fields defined by

$$B_x = \frac{2B_0}{a^2} xy \quad (12)$$

$$B_y = \frac{B_0}{a^2} (x^2 - y^2) \quad (13)$$

where B_0 is the field at the pole and a is the radius of the sextupole aperture. For modulation in the x-plane ($y=0$) we have only

$$B_y = \frac{B_0}{a^2} x^2. \quad (14)$$

Through the Lorentz force the field B_y provides a kick to the beam and changes the angle according to

$$\Delta\theta = 2.998 \times 10^{-4} \frac{B_y (G) L (cm)}{E (MeV)} \quad (15)$$

$$\Delta\theta = \frac{2.998 \times 10^{-4} B_0 L}{a^2 p_z} x^2 = Sx^2 \quad (16)$$

Applying this result at the exit of the sextupole we have

$$X_{s+} = (ML)_{12} A_1 \cos \omega_1 t + M_{12} A_2 \cos \omega_2 t \quad (17)$$

$$X'_{s+} = (ML)_{22} A_1 \cos \omega_1 t + M_{22} A_2 \cos \omega_2 t + S \begin{bmatrix} ((ML)_{12})^2 A_1^2 \cos^2 \omega_1 t + \\ 2(ML)_{12} (M_{12}) A_1 A_2 \cos \omega_1 t \cos \omega_2 t + \\ (M_{12})^2 A_2^2 \cos^2 \omega_2 t \end{bmatrix}. \quad (18)$$

Using trigonometric identities we can rewrite Eq. 18 as

$$X'_{s+} = (ML)_{22} A_1 \cos \omega_1 t + M_{22} A_2 \cos \omega_2 t + S \begin{bmatrix} ((ML)_{12})^2 A_1^2 \frac{1}{2} [1 + \cos 2\omega_1 t] + \\ (ML)_{12} (M_{12}) A_1 A_2 [\cos(\omega_1 + \omega_2)t + \\ \cos(\omega_1 - \omega_2)t] + (M_{12})^2 A_2^2 \frac{1}{2} [1 + \cos 2\omega_2 t] \end{bmatrix}. \quad (19)$$

In addition to the initial frequencies of ω_1 and ω_2 we now also have $2\omega_1$, $2\omega_2$, $\omega_1 + \omega_2$ and $\omega_1 - \omega_2$ appearing in the expansion. The N transfer matrix finally takes the beam from the exit of the sextupole to the BPM resulting in these same spectra appearing in the position and angle data which can now be measured.

$$\begin{pmatrix} X_{bpm} \\ X'_{bpm} \end{pmatrix} = \begin{pmatrix} N_{11} & N_{12} \\ N_{21} & N_{22} \end{pmatrix} \begin{pmatrix} X_{s+} \\ X'_{s+} \end{pmatrix} \quad (20)$$

$$X_{bpm} = N_{11} X_{s+} + N_{12} X'_{s+} \quad (21)$$

$$X'_{bpm} = N_{21} X_{s+} + N_{22} X'_{s+} \quad (22)$$

EXPERIMENT

The experiment was conducted using pairs of AC dipole magnets driven at 1 Hz and 21 Hz in the x-plane or y-plane (Fig. 3). These magnet pairs, located at the entrance of CEBAFs first recirculation ARC, are separated by ~22 m. The time domain data from the beam modulation was captured using eight of our antenna-style beam position monitors with all 32 antennae connected to a high speed Data Acquisition System.

A beam structure of 100 μ s macropulses at a repetition rate of 500 Hz was used. The daq was triggered at this rate, delayed 30 μ s to allow for RF transients to pass, and then acquired 70 samples which were averaged to provide the data for that pulse. The amplitude and phase of the kicker magnets was also captured by the daq.

One of the ARC sextupole magnets was initially used as a calibration standard to benchmark the measurement technique. Measurements of a pair of CEBAF ARC dipoles were then conducted to determine the nonlinear field content of these 1 m dipoles. A local closed orbit bump was used to offset the beam within the dipoles and measure the nonlinear fields across the magnet midplane.

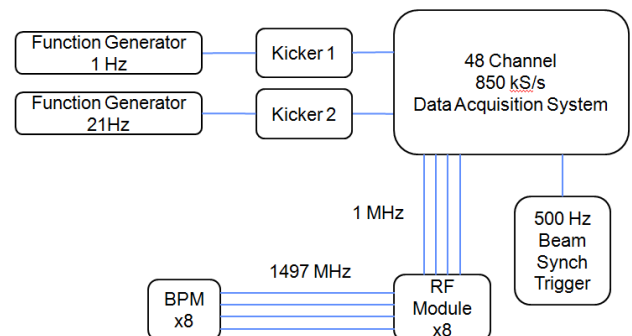

Figure 3: Hardware setup for dual AC dipole studies.

Sextupole Measurements

Beam modulation in the x-plane and y-plane were performed as a function of field strength for one of the ARC1 sextupoles. All other sextupoles in the ARC were degaussed during the measurements. Fourier analysis of the time domain data was used to find the frequencies and the NAFF technique [3] was used to find the amplitudes as a function of field strength.

Figure 4 shows an Elegant simulation of a sextupole with beam modulation in the y-plane alongside a beam based measurement for a sextupole field of 1000 G/cm. The primary peaks at 1 Hz and 21 Hz are observed as well as the harmonics from the second order sextupole.

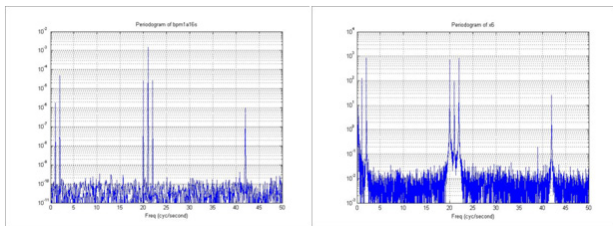

Figure 4: Comparison of an Elegant simulation (left) with a beam measurement (right) of sextupole spectra.

The measured amplitudes of the peaks scale linearly with the strength of the sextupole (Fig. 5). With knowledge of the transfer matrices between elements we can now measure nonlinear fields in the lattice.

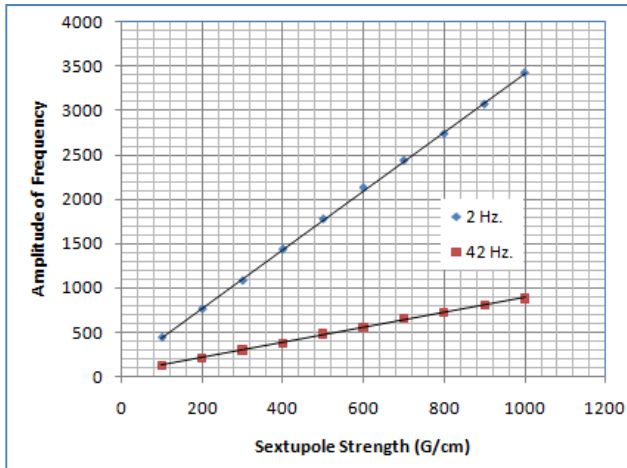

Figure 5: A linear relationship is observed between the second order peaks and the sextupole strength.

Dipole Measurements

The CEBAF ARC1 beamline is a 250 m long π -bend consisting of 16 one meter dipoles. The magnets were characterized with a Hall probe stepper system in our Magnet Measurement Facility. Twenty-one different tracks through the dipole were measured with a spacing of 5 mm. A data point was taken every 2 mm along each track to create a grid of points. The data was analyzed along curved trajectories to calculate multipoles at

different paths relative to the nominal reference orbit. Figure 6 shows the results for sextupole strength.

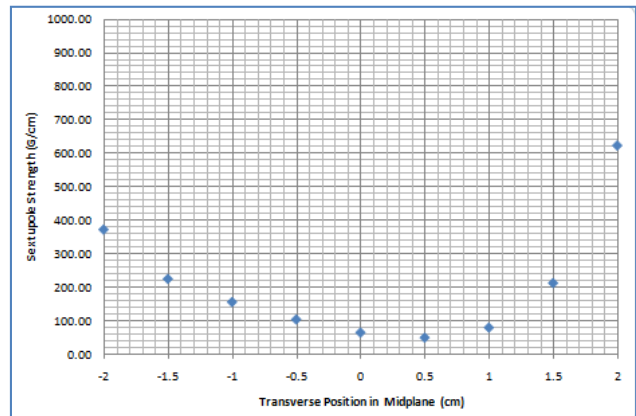

Figure 6: Magnet measurement data of an ARC1 dipole.

Beam-based measurements of dipole field nonlinearity were done with modulations in the y-plane at different transverse positions within a pair of adjacent dipoles. The beam was offset with a local orbit bump within the magnets and steered back onto the design orbit at a downstream BPM for measurements. Figure 7 shows the amplitude of the peaks.

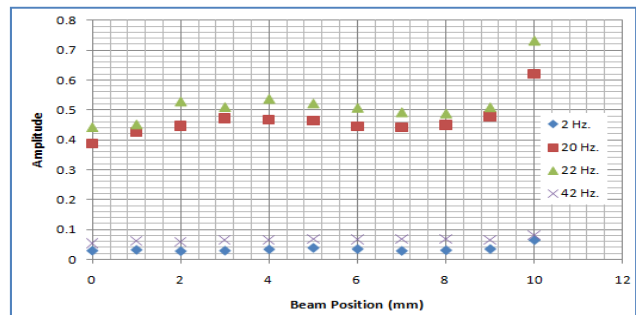

Figure 7: Amplitude of peaks for dipole measurements.

CONCLUSION

Dual AC dipoles have been used to develop a technique for characterizing field nonlinearities in the CEBAF lattice. Calibration runs with a single sextupole were done to provide a benchmark for measuring arbitrary segments of the beamline. Measurements of dipole field nonlinearities were done for a pair of magnets in an ARC.

REFERENCES

- [1] M. Borland, "elegant: A Flexible SDDS-Compliant Code for Accelerator Simulation," Advanced Photon Source LS-287, September 2000.
- [2] L. Merminga, et al., "Beam Physics for the 12 GeV CEBAF Upgrade Project," PAC'05, p.1482; <http://www.JACow.org>
- [3] J. Laskar, C. Froeschlé and A. Celletti, Physica D, 56 (1992) 253